

Lack of access to medicine is a major driver of drug resistance. How can pharma take action?

JUNE 2022

Antimicrobial resistance (AMR) is rising faster than expected. Worldwide, more than one million people die of AMR each year, most of them in low- and middle-income countries (LMICs). Resistant infections can rapidly spread without appropriate access to essential antibiotics and antifungals. Yet, the issue of responsibly providing access for people living in resource-poor settings has been largely overlooked. Pharmaceutical companies are only using a limited number of the opportunities that exist to expand access in poorer nations, resulting in significant gaps. This study sets out how companies and their partners are using a combination of access strategies to cut through the complexity and address access at a local level.

ACKNOWLEDGEMENTS

The Access to Medicine Foundation would like to thank the following people and organisations for their contributions to this report.

FUNDERS

UK Foreign, Commonwealth and Development Office
The Dutch Ministry of Health, Welfare and Sport
AXA Investment Managers
Wellcome Trust

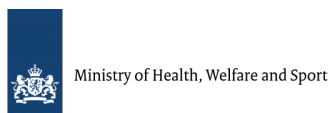

RESEARCH TEAM

Moska Hellamand
Martijn van Gerven
Fatema Rafiqi

EDITORIAL TEAM

Marjolein van der Boon
Eleanor Bley Griffiths
Rachel Jones

EXPERT REVIEWERS

Anthony McDonnell, Center for Global Development (CGD)
Jean-Pierre Paccaud, Jennifer Cohn, Global Antibiotic
Research and Development Partnership (GARDP)

ADDITIONAL CONTRIBUTORS

The Access to Medicine Foundation is grateful to the following for their thoughtful contributions to the development of this paper: Andy Gray (University of KwaZulu-Natal); Dame Sally Davies (UK Special Envoy on Antimicrobial Resistance); John Rex (F2G Ltd., AMR.Solutions, Advent Life Sciences, McGovern Medical School in Houston, Texas); Katherine Klemperer (CGD); Marc Mendelson (University of Cape Town, Groote Schuur Hospital); Nelesh Govender (University of the Witwatersrand, National Institute for Communicable Diseases at NHLS in South Africa); Neel Lakhani, David Ripin (CHAI); Yann Ferrisse (GARDP).

RESEARCH AND EDITORIAL SUPPORT

Camille Romero
Diane Dinar-Farjon
Anna Massey

ACCESS TO MEDICINE FOUNDATION

The Access to Medicine Foundation is an independent non-profit organisation based in the Netherlands. It aims to advance access to medicine in low- and middle-income countries by stimulating and guiding the pharmaceutical industry to play a greater role in improving access.

Naritaweg 227-A
1043 CB, Amsterdam
The Netherlands

For more information about this publication, please contact Fatema Rafiqi, Research Programme Manager
frafiqi@accesstomedicinefoundation.org
+31 (0) 20 215 35 35
www.accesstomedicinefoundation.org

Table of contents

4	About this paper
5	Introduction AMR is rising fast. Lack of access is making the problem worse.
8	How can pharmaceutical companies expand access? A wide range of strategies are available to companies.
11	What is the state of play for companies looking to bring anti-biotics and antifungals to more people? The antibiotic market is broken. How can we fix it?
16	Case studies Companies that are using a combination of access strategies to make specific medicines more widely available.
25	Discussion Collaboration between stakeholders is a key ingredient.
29	Recommendations What can stakeholders do to expand appropriate access?
31	Appendix
34	Definitions
36	References

About this paper

This paper is part of the Access to Medicine Foundation's Antimicrobial Resistance (AMR) Research Programme, which takes an in-depth look at how the pharmaceutical industry is responding to the growing challenge of drug-resistant infections. The Research Programme has assessed companies' performances in AMR Benchmark reports published in 2018, 2020 and 2021. These provided data-driven analyses of actions by companies with a major stake in the anti-infectives space, including research-based pharmaceutical companies and generic medicine manufacturers.

This paper builds further on a key finding of the 2021 AMR Benchmark, namely that pharma companies are making limited use of the many ways to improve access to antibiotics and antifungals in low- and middle-income countries (LMICs) – and where access strategies are in place, that they remain focused on a small set of countries, people and diseases. However, the Benchmark also noted that there are tangible ways that access can be improved, making a real difference to millions of people if deployed more widely. This paper set out to uncover the systemic factors that may be preventing companies from prioritising access, as well as identifying case studies and recommendations for companies and other stakeholders such as governments, procurement agencies and regulatory bodies.

This is the first of three stand-alone studies that the AMR Research Programme will publish in 2022 - 2024.

HOW WAS THE PAPER DEVELOPED?

The case studies, discussion and recommendations in this thematic study have been drawn from research published in the 2021 AMR Benchmark, as well as from interviews held with companies and experts in the AMR field. It was further informed by sources available in the public domain. Information from these sources was cross-checked directly with companies and their partners to ensure accuracy.

SCOPE OF THE RESEARCH

Companies

This study includes case studies on research-based pharmaceutical companies and generic medicine manufacturers that are marketing antibacterial and antifungal medicines in LMICs. The following companies are specifically mentioned: Cipla, MSD, Pfizer, Sanofi, Shionogi and Viartis.

Products

This study includes examples of on-patent, off-patent and generic antibacterial and antifungal medicines, specifically: amoxicillin, beta-lactams, cefiderocol (Fetroja®/Fetroja®), ceftaroline (Zinforo®), ceftazidime/avibactam (Zavicefta™), ceftolozane/tazobactam (Zerbaxa®), colistin, doxycycline, flucytosine, fosfomycin, liposomal amphotericin B, metronidazole and (benzyl)penicillin.

EXPERT REVIEWERS

Anthony McDonnell, Center for Global Development (CGD)

Jean-Pierre Paccaud, Jennifer Cohn, Global Antibiotic Research and Development Partnership (GARDP)

SOURCES

Sources for this study include interviews with companies and experts, company websites, partner websites, proprietary data from IQVIA, as well as information from the Foundation's 2021 AMR Benchmark and the 2021 Access to Medicine Index. It also draws on information available in the public domain, including peer-reviewed literature, company and global health reports, policy literature and government documents.

INTRODUCTION

AMR is rising fast. Lack of access is making the problem worse.

Antimicrobial resistance (AMR) is rising even faster than anticipated. Drug-resistant infections are already causing millions of preventable deaths each year. In 2019 alone, there were an estimated 4.95 million deaths associated with AMR and more than one million people died as a direct result of antibiotic resistance.¹ If the current situation is not addressed, the death toll will continue to increase.

Antibiotic and antifungal medicines are not only vital in treating infections. They also play an essential role in preventing infections, for example after surgery, for immunocompromised people, such as those with HIV/AIDS, and for people undergoing aggressive cancer treatments.³ These medicines are also critical tools in protecting newborns, whose immune systems have not yet fully developed, from bacterial and fungal infections.

The world's poorest countries experience the greatest rates of infectious disease and the highest levels of antibiotic resistance – but it is precisely these countries that suffer the biggest gaps in access to the right treatment. Further, while many global health discussions focus on curbing AMR, the lack of access to essential antibiotics and antifungals for people living in low- and middle-income countries (LMICs), especially for the most vulnerable and marginalised populations, does not receive the same level of attention.

Access to antibiotics and antifungals is vital and must increase

It is absolutely crucial that every patient has access to the right antibiotic or antifungal medicine at the right time, no matter where they live in the world. This can sound paradoxical, because overuse or misuse of antibiotics and antifungals is also a major driver of resistance.⁴

However, when antibiotics and diagnostics are unavailable, it not only has a huge toll on those directly affected by disease, but also poses a danger to the wider population. This is because if the right treatment is not accessible doctors have to resort to suboptimal treatments, which gives pathogens an opportunity to develop resistance.

IN BRIEF

- ▶ AMR is rising fast, with the world's poorest countries bearing the biggest burden.
- ▶ A lack of access to antimicrobials is making the problem worse.
- ▶ Improving access, supported by strong stewardship, must get more attention from pharma companies, governments and procurers.

How many people are dying from drug-resistant infections

700,000 deaths directly due to AMR in 2014



1.27 million deaths due to AMR in 2019

4.95 million deaths were associated with AMR in 2019

Sources: *The Review on Antimicrobial Resistance* (Jim O'Neill), 2014² and the *GRAM report*³

How lack of appropriate access drives antimicrobial resistance (AMR)

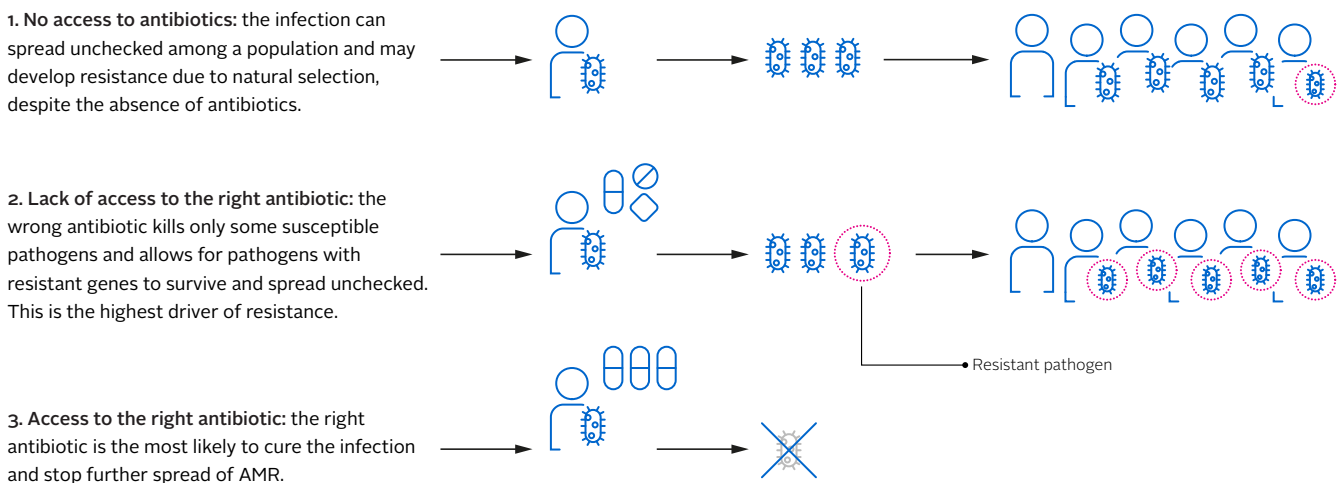

While AMR is a global issue, a lack of access to antibiotics and antifungals is especially urgent in LMICs, where many medicines have not been registered with national regulatory bodies, which means they cannot be sold or distributed to the patients who need them.⁵⁻⁸ As a result, the people who face the highest risk of infection and the highest rates of drug resistance have the hardest time getting the antibiotics they need to survive severe bacterial and fungal infections. This is why it is critical that pharmaceutical companies, governments and procurers take action to ensure access to antibiotics and antifungals.

But it is equally critical that access is 'appropriate'. 'Appropriate access' means that essential medicines are made available, affordable and accessible while also ensuring they are covered by strong stewardship practices, i.e., making sure that antibiotics and antifungals are being used responsibly so they stay effective for as long as possible.

To turn around this lack of equity, we must expand our focus beyond stewardship and the hunt for replacement antibiotics. Furthermore, access to medicines and diagnostics already on the market must get the same level of attention as novel ones, particularly in the world's poorest regions.

The human toll of AMR

- 1.27 million deaths per year are directly attributable and almost 5 million deaths per year are associated with antibacterial resistance.
- Death rates due to resistance are highest in Western sub-Saharan Africa with 27.3 deaths out of 100,000. The four regions with the highest burdens are in sub-Saharan Africa, followed by South Asia.
- *E. coli* bacterial infections account for most deaths attributed to resistance, followed by *K. pneumoniae*, *S. aureus*, *A. baumannii* and *S. pneumoniae*.
- Lower respiratory infections, bloodstream infections and intra-abdominal infections have the most global deaths attributed to antibacterial resistance.

Source: *The Global Research on Antimicrobial Resistance (GRAM) report, published in The Lancet in January 2022, the most comprehensive study yet of the extent of AMR globally.*

How lack of appropriate access drives AMR

When the right, first-line antibiotics and antifungals are not locally accessible, a doctor may resolve to prescribing a less effective alternative. Not only is this less likely to cure the patient's infection, but it can also contribute to AMR. Pathogens can adapt to the pressure of antibiotics by selecting genes that are resistant to the antibiotic. The wrong antibiotic kills only some susceptible pathogens and allows for the pathogens with resistant genes to survive and spread unchecked. When first-line treatments are unavailable, doctors may also resort more quickly to antibiotics that should be second- or third-line treatments, which should be held in reserve in order to protect their effectiveness for as long as possible. Lack of access to diagnostics exacerbates this problem, making it even harder for doctors to prescribe the correct antibiotic.

The implications for AMR are even wider when no antibiotics or antifungals are available and the patient does not receive any treatment. Appropriate access to the right treatment not only prevents suffering and death, but it also helps to control the spread of infection and limit the rise of AMR. When infections are allowed to spread unchecked among a population, pathogens may develop resistance due to natural selection, despite the absence of antibiotics.

What antibiotics and antifungals are needed?

To support the appropriate use of antibiotics, the World Health Organization (WHO) has grouped essential antibiotics into three categories: Access, Watch and

Where are people facing the highest risk of dying from drug-resistant infections?

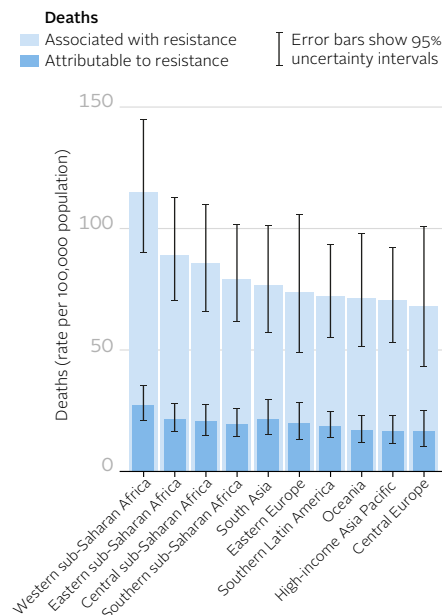

Source: the GRAM report¹

How many people are dying from the most deadly drug-resistant pathogens

<i>E. coli</i>	220,000
<i>K. pneumoniae</i>	190,000
<i>S. aureus</i>	180,000
<i>A. baumannii</i>	130,000
<i>S. pneumoniae</i>	120,000

Source: the GRAM report¹. These numbers are estimates.

Which infectious diseases have the most deaths attributed to AMR?

Lower respiratory infections	415,000
Bloodstream infections	375,000
Intra-abdominal infections	208,000
Tuberculosis	84,000
Urinary tract infections	65,000

Source: the GRAM report¹. These numbers are estimates.

Reserve, also called the AWaRe classification (see box below). Antifungal medicines have not been categorised in this way, though it is important that they are also classified to ensure their appropriate use. The rising incidence of fungal infections and antifungal resistance is now receiving greater attention, however, including the push for more drug development.⁹ While WHO uses the AWaRe classification to prioritise groups of antibiotics, we still rely on pharmaceutical companies to make them available, accessible and affordable.

WHO AWaRe Classification

The majority of antibiotic and antifungal medicines are older, off-patent products that fall under the Access category. ‘Access’ antibiotics are typically first- and second-line treatments that should always be accessible to treat common infections. They are widely needed medicines, such as doxycycline, a broad-spectrum first-line antibiotic for chlamydia and cholera; and benzylpenicillin, used to treat syphilis.

Making Access antibiotics available for everyone, under strictly observed stewardship practices, also helps to preserve the effectiveness of Watch and Reserve antibiotics. While both should be accessible, Watch antibiotics should only be prescribed for a limited set of indications and Reserve antibiotics should only be used as last-resort treatments against the most resistant bacteria.¹⁰

Reserve antibiotics in particular are intended to treat multi-drug-resistant and extensively drug-resistant infections and should only be used “when all alternatives have failed or are not suitable.”¹⁰ If pathogens develop resistance to Reserve antibiotics, also known as non-renewable antibiotics, there are currently no more options left in the medicine cabinet.

Where are companies filing antibiotics and antifungals for registration?

The AMR Benchmark examined registration filings from 17 companies. There are various reasons why a company may or may not file a product for registration in a specific country, including market size and financial opportunities, government price policies, local regulatory requirements and data needed for registration.

● 0 filings ● 1-10 filings ● 11-30 filings ● 30-50 filings ● > 50 filings ● Registration filings not assessed.
 This analysis focused on low- and middle-income countries where the need for better access to medicine is greatest.

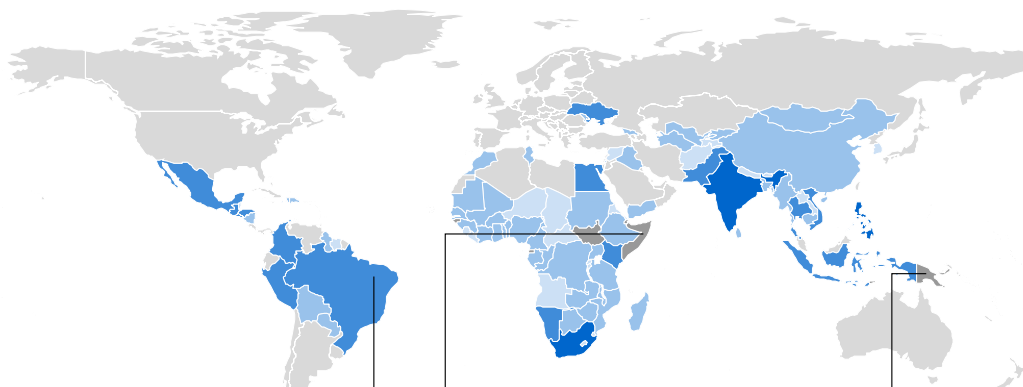

More products have been filed for registration in Brazil, South Africa, the Philippines, India and Thailand. They provide greater revenue opportunities due partly to large patient populations.

There are 14 countries in which none of the 148 products examined have been filed for registration, including Somalia and South Sudan.

Filing for registration is a vital first step to introduce a product into a country, as it allows it to be imported and sold.

Source: 2021 AMR Benchmark

How can pharmaceutical companies expand access?

Since 2017, the Access to Medicine Foundation has been tracking how a cross-section of pharmaceutical companies active in the antibiotics and antifungals field ensures access to these products in low- and middle-income countries (LMICs). This research shows that pharmaceutical companies are only utilising a limited number of opportunities to expand access to their antibiotics and antifungals in LMICs, resulting in a significant gap in access to essential medicines in these countries.

The latest AMR Benchmark report, published by the Foundation in 2021, found that just one third of the products analysed were covered by an access strategy in the 102 resource-limited countries in scope (see figure).⁸ A wide range of access strategies were considered in the report, including technology transfers, equitable pricing strategies and voluntary licensing agreements.

Pharma can break the pattern of inaction

While there are many ways to improve access to vital antibiotics and antifungals in poorer countries, these are not being widely used. While pharmaceutical companies expect governments to prioritise stewardship measures and prevent an influx of low-quality medicines, governments expect companies to communicate which antibiotics or antifungals they are planning to introduce into their health systems. This leads to a stalemate that affects people in poorer countries the most. Low-income countries (LICs), home to nearly 700 million people, are particularly overlooked by companies' access strategies even though the pharmaceutical industry can save lives by reaching more people with more products, both old and new. Access strategies by pharmaceutical companies need to increase in quality and reach in order to cover a wider range of countries, people and treatments.

A toolkit of access strategies for companies

For each antibiotic or antifungal, pharmaceutical companies should consider the full range of access strategies in the toolkit to work out what is most useful to reach vulnerable populations living in LMICs. Tangible access strategies are highlighted and explored in this report, including in several case studies where companies have addressed access to specific antibiotics and antifungals.

The next pages provide an overview, as well as definitions, of the access strategies available to pharmaceutical companies and other key stakeholders. This includes approaches to enable availability such as registration, but also ways to expand access to underserved populations, such as patient assistance programmes and equitable pricing policies. Increase of local availability via technology transfers to qualified manufacturers is also vital in regions where there is a dependency on importation, for example in sub-Saharan Africa.

In addition to what pharmaceutical companies can do, this report also draws attention to steps other stakeholders, such as governments and procurement agencies, can take to enable the supply and production of essential antibiotics and antifungals in LMICs. This includes working with healthcare professionals to collect and share data about which antibiotics are needed where, creating conditions to ensure a sustainable market for novel products, and streamlining registration procedures for generic products.

IN BRIEF

- ▶ A wide range of strategies are available to companies for improving access appropriately and sustainably.
- ▶ Currently they are only using a fraction of the options available.
- ▶ For each essential antibiotic or antifungal, companies should consider the full range of access strategies in the toolkit.

Number of antibiotics & antifungals covered by at least one access strategy

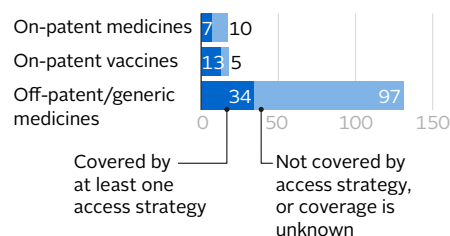

Source: 2021 AMR Benchmark. The Benchmark examined the portfolios of 17 companies.

Newly approved products identified by the AMR Benchmarks

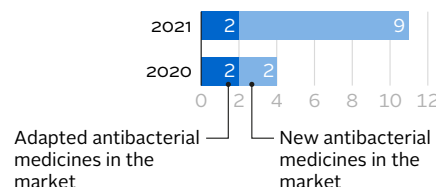

Source: 2021 AMR Benchmark

THE TOOLKIT OF ACCESS STRATEGIES FOR PHARMACEUTICAL COMPANIES

Action to improve the availability and accessibility of medicine is urgently needed, with each antibiotic and antifungal being used responsibly to ensure it stays effective for as long as possible. For each antibiotic and antifungal, companies should consider the full range of access strategies in the toolkit.

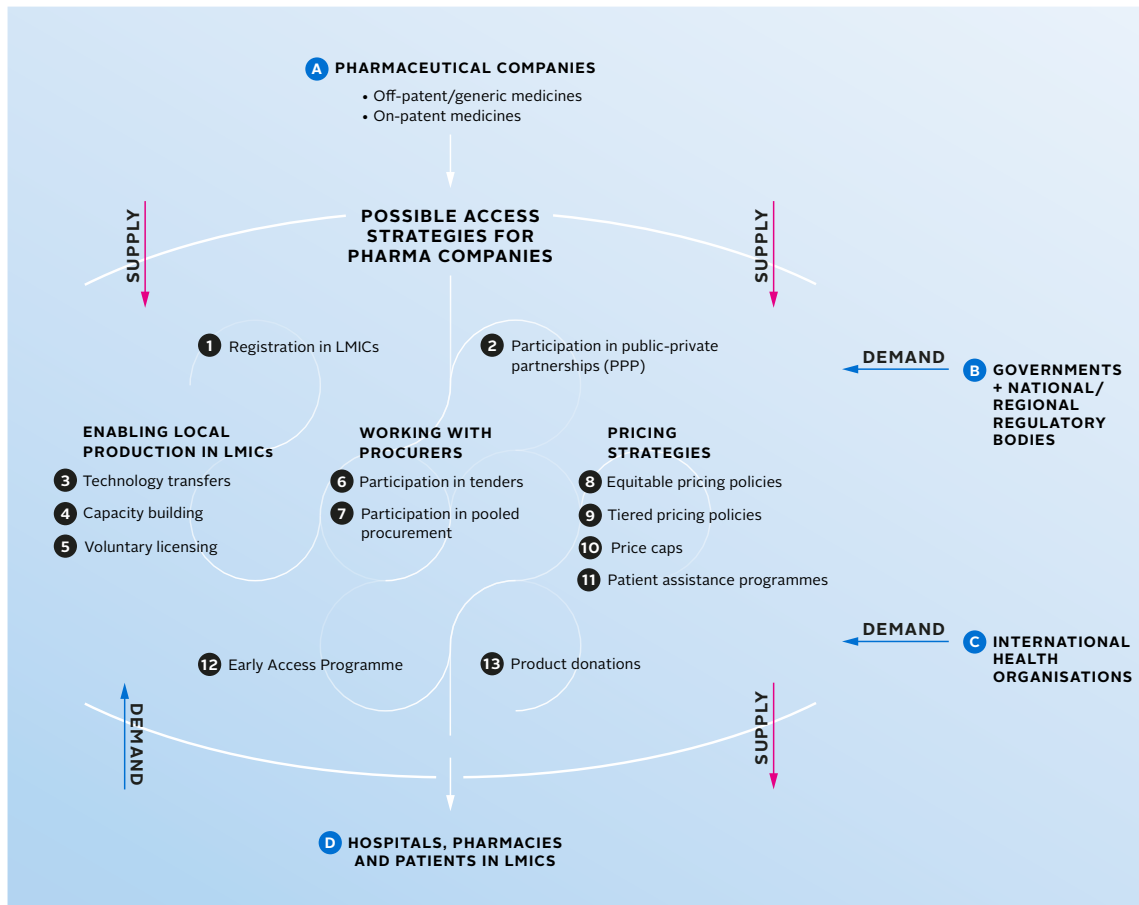

A CLOSER LOOK – WHAT DOES EACH STRATEGY ENTAIL?

1 Registration in LMICs: Filing for registration is a vital first step towards introducing a medical product into a country, as successful registration means that a product is now allowed to be imported and sold.

2 Participation in public-private partnerships (PPP): Partnerships between public or civil society organisations and the private sector (i.e., the pharmaceutical industry) that work towards mutually defined goals based on public needs. Such long-term partnerships are characterised by sharing investments, risks, rewards and responsibilities.

Enabling local production in LMICs

3 Technology transfers: A pharmaceutical company transfers knowledge about the process to make a specific

medicine or vaccine to a manufacturing site in a country where that product is needed, along with the technology necessary to manufacture it.

4 Capacity building: A pharmaceutical company forms partnerships with local stakeholders to increase capacity (e.g., by training staff or obtaining equipment and other necessary resources) in order to strengthen the supply chain.

5 Voluntary licensing: A voluntary license is an authorisation given by a patent holder to a generic medicine manufacturer, allowing the manufacturer to produce a patented medicine or vaccine, often at a lower cost. The license usually sets quality requirements and defines the countries in which the licensee can sell the product.

Working with procurers

6 Participation in tenders: Tenders are competitive procedures where bids are invited from companies that can provide medicines to procurers (e.g., governments or health organisations). They can be an effective tool for procurers to secure a volume of medicines or vaccines at a specific price.

7 Participation in pooled procurement: Pooled procurement means procurers (e.g., governments or health organisations) combine resources and order volumes in order to purchase medicines.

Pricing strategies

These can be used by pharmaceutical companies to address affordability and help ensure that their products are not financially out of reach for the people who need them, or the health systems that need to procure them.

8 Equitable pricing policies: Prices are set within the ability of specific populations to pay, with reference to a range of socio-economic factors.

9 Tiered pricing policies: Also known as differential pricing, this refers to when buyers with different income levels – e.g., low-income or high-income countries – are charged different prices for the same product.

10 Price caps: A maximum price that can be charged for a product, usually negotiated between a government and a pharmaceutical company.

11 Patient assistance programmes: Programmes initiated by pharmaceutical companies that provide financial assistance or free-of-charge medicines for a defined patient population with limited ability to pay.

12 Early Access Programmes: A pathway allowing patients to access patented or generic medicines that have not yet been registered in a country. These programmes typically include medicines for serious or life-threatening diseases when there are no other treatment options available.

13 Product donations: Short-term donations or long-term donation programmes based on the needs of a specific population. Donations of antibiotics may be made in emergency situations, such as conflict or natural disasters, or to eliminate a neglected tropical disease (NTD). For people living in poverty, donations may be their only chance of getting access to the treatment they need.

Stakeholders

There are different roles for each stakeholder in the antibiotics and antifungals market.

A Pharmaceutical companies: Pharmaceutical companies have a role in expanding access to their antibiotics and antifungals in LMICs through the variety of access strategies displayed here.

B Governments + regulatory bodies: Local governments can play a valuable role in enabling pharmaceutical companies to expand access in their countries, for example by providing data to highlight demand for different antibiotics and antifungals. Regulatory bodies, for example, can harmonise and simplify registration procedures.

C International health organisations and procurers: Procurement agencies, such as governments and international health organisations, have a role in selecting suppliers for their procurement. They can influence pricing as well as the diversity of the supply chain.

D Hospitals, pharmacies and patients in LMICs: Healthcare professionals and patients can ensure stewardship policies are followed so that antibiotics and antifungals are used appropriately.

What is the state of play for companies looking to bring antibiotics and antifungals to more people?

Antibiotics are essential medicines for all healthcare systems – yet the antibiotic market is fundamentally broken. Tough market conditions are characterised by fragile supply chains, low margins for older medicines, small patient numbers for newer medicines, and are compounded by variations in regulatory requirements. Numerous pharmaceutical companies have left the anti-infectives market in recent years.¹¹

The few companies that remain active in this space face some hurdles when they seek to introduce a product to a specific market. The incentives and choices they face differ between whether the product is novel and therefore on-patent, or whether it is an older, off-patent or generic medicine.

OFF-PATENT/GENERIC MEDICINES

Challenges with the go-to-market model for generic medicines

The market for older, off-patent/generic products in low- and middle-income countries (LMICs) – while serving many more patients than on-patent products – is challenging and uncertain. The complex and diverse challenges in the off-patent/generic market for antibiotics and antifungals result in a lack of registration filings of these essential medicines, especially in LMICs.

Companies lack insight into market opportunities, but are aware of thin profit margins, resource-intensive registration procedures and fragile supply chains. The outcome of these challenges is that generic medicine manufacturers may only enter bigger LMIC markets with clearer demand and higher sales volumes, and skip poorer countries with smaller markets where people are most affected by antimicrobial resistance (AMR). In other cases, companies may opt out of the off-patent/generic market for antibiotics and antifungals in LMICs entirely.

There are three structural factors that, tackled together, can facilitate the development of a replicable and scalable go-to-market model for such products in LMICs:

1. Insight into local demand via patterns of infection and resistance

Understanding local demand is key for companies that want to introduce their generic antibiotics and antifungals into a new market. Without data on local demand, it is more challenging for a company to assess whether the resources invested and costs incurred when entering a new market are a reasonable investment. Generic medicine manufacturers often do not have operations set up in a large proportion of LMICs. These companies have historically prioritised countries with larger patient numbers and a greater capacity to pay for medicines, such as Brazil, China, India, Kenya, Nigeria and South Africa.

Insight into local demand is necessary to make the case for registering generic medicines, which is a vital first step to introducing a product into a market because it allows importation and sale. The 2021 Benchmark found that only 14% of off-patent/generic products are filed for registration in 10 or more out of 102 LMICs it covers. When companies fail to register medicines in LMICs, this has consequences for local drug resistance. In South Africa, for example, many Access antibiotics are unavailable, so Watch antibiotics - broad-spectrum antibiotics with a higher potential for resistance - are routinely taken as a first-line treatment.

The level of local demand can be demonstrated by data from surveillance programmes, which track the rise of resistance and spread of infection in a given

IN BRIEF

- ▶ The antibiotic market is unstable, with fragile supply chains and tough market conditions.
- ▶ Insight into local demand, diversifying supply chains and long-term procurement strategies via tenders can mend the go-to-market model for older medicines.
- ▶ Access to on-patent medicines is low in poorer countries. Working with partners on manufacturing and implementing access programmes can help to deliver access at scale.

Out of 19 surveillance programmes by companies identified by the 2021 Benchmark, five were running in at least one African country.

High-income countries are consistently covered, while countries in Central Asia and Africa are sporadically covered by company surveillance programmes.

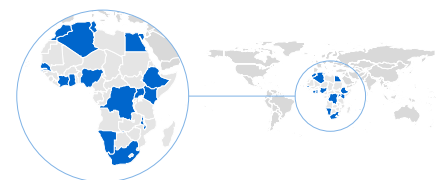

Source: 2021 AMR Benchmark

region. This shows where there is an unmet medical need for a specific product, which is important to decide whether and where to file for registration. Surveillance programmes are typically run by governments and public health authorities. The data is used to measure and respond to the spread of resistant infections and prioritise objectives for stewardship policies. In 2015, the World Health Organization (WHO) launched the Global Antimicrobial Resistance and Use Surveillance System (GLASS), which is the first global collaborative effort to standardise AMR surveillance. In LMICs, however, the use of surveillance programmes can be scarce, making it difficult to map out the need for a specific product.

Another way to offset barriers to registration is to harmonise the regulatory procedures used by countries in a region, or by using collaborative registration procedures (CRP). Both of these approaches reduce the need for companies to gather and submit different data sets for each country in which they want to introduce their products. Regulatory harmonisation and CRP can increase the number of countries where companies file for registration. For example, the prospective African Medicines Agency (AMA) can be helpful in simplifying the registration procedure in participating countries.

2. Strengthened supply chains of APIs and finished products

Shortages and stockouts can be prevented by strengthening the supply chain for medicines across all stages, from active pharmaceutical ingredients (APIs) to finished products. A fragile and fragmented antibiotic supply chain is at greater risk of failure, which can lead to stockouts and shortages and higher distribution costs. These factors further erode the slim margins that characterise the market for generic medicines and can increase the final price for the patient.

Manufacturing of key ingredients, or APIs, for antibiotics is concentrated in a few regional hubs - mainly India and China. China, for example, is home to about 40% of global production of APIs.¹² Yet, antibiotic supply chains can be complex, with many players. This leads to low visibility and accountability, with little alignment to ensure supply matches demand. As a result, some populations face shortages, while others are offered poor quality medicines, or gain excessive access to antibiotics that should be tightly controlled to keep resistance in check. The fragility of supply chains for medicines has been further highlighted during the COVID-19 pandemic. Closures of borders, spikes in demand, and supply interruptions have overwhelmed and affected governments, pharmaceutical companies and health systems along with individual patients.

To strengthen supply chains, manufacturers can move away from single-source or limited supply chains of both APIs as well as finished products for antibiotics and antifungals. This may involve expanding the raw material supplier network and looking carefully at which suppliers to use. Technology transfers, capacity building, and collaborations between multinational corporations and local manufacturers can all strengthen supply chains and boost local availability of essential medicines.¹³

3. Sustainable procurement via tenders

Margins in the generics medicine market are slim, but tenders can be a way to enable sustainable access to essential medicines. With hundreds of companies manufacturing generic medicines, there is fierce competition to supply specific products. Further, because generic versions of the same medicine are by definition identical, companies can predominantly compete on price but also on, for example, supply conditions. This gives greater negotiating power to buyers, such as governments and other procurers, that typically use competitive tendering to procure medicines in bulk. These tenders are generally structured so as to reward the lowest bidder. Therefore, competitive tenders lead to more affordable prices for patients, yet they can also lead to an unattractive market if the sales volume expectation, as well as the price, is low.

The biggest complexity here lies in sales volume expectations, since it is hard for pharmaceutical companies to predict demand. If demand for a product is poorly understood, this can be aided through estimations of pooled demand by procurement agencies. There is increasing awareness among buyers that promoting long-term sustainability should be a key decision-making factor in procurement, however this has yet to become mainstream practice. Encouraging long-term sustainability includes looking beyond pricing and quality of medicines at security and continuity of supply. This way, tenders can enable continuous access to antibiotics and antifungals.

However, most patients living in LMICs pay out of pocket and tenders typically do not cover products that are paid this way, nor do they mean that pharmaceutical companies should not use other access strategies to reach more patients in LMICs. For example, the 2021 AMR Benchmark found that for a total of 148 antibacterial and antifungal medicines, only 26% of off-patent/generic medicines are covered by access strategies, compared to 41% of the on-patent medicines.

ON-PATENT MEDICINES

Why on-patent antibiotics and antifungals are not introduced at scale

The number of novel, on-patent antibiotics and antifungals currently available is very limited. Pharmaceutical companies that remain active in antibacterial and antifungal R&D are mainly focused on developing new antibiotics that will work against multidrug-resistant infections, such as tuberculosis. The result is that successful new medicines are almost always classified as Reserve antibiotics, prioritised for last-resort treatment and subject to stringent stewardship protocols.

On-patent antibiotics are usually only introduced in countries with an unmet medical need and where specific conditions are met, including a financially viable and sustainable market or payment model, and a health system that can prevent misuse and overuse. The latter means the country should have suitable healthcare infrastructure for stewardship measures, such as accurate and up-to-date treatment protocols, essential diagnostics, and healthcare professionals with an understanding of resistance patterns, in order to avoid the development of resistance to novel antibiotics. Many poorer countries do not have these systems in place and as a result, novel, on-patent antibiotics and antifungals are not introduced at scale to patients living in LMICs.

Differences in local health systems create a further layer of complexity. International health organisations can take steps to address these further challenges. For example, in Ethiopia, where the limited reserves of foreign exchange are managed by the National Bank of Ethiopia, local distributors must depend on the amount of foreign exchange allocated to them, reducing the opportunities to purchase essential medicines. International health organisations, alongside companies, are among the key stakeholders making medicines available. For example, Clinton Health Access Initiative (CHAI) has a local programme that aims to increase access to diagnostics and antibiotics to treat pneumonia, which causes 18 percent of all child deaths in the country.¹⁴

To meet these challenges in the on-patent market, governments of high-income countries and international organisations have been exploring push and pull incentives designed to stimulate pharmaceutical industry engagement and investment in antibiotic R&D. Firstly, organisations such as CARB-X and several governments are pushing for more antimicrobial R&D by using market-entry rewards, subscription models and grants. This could lead to more new product launches, thereby widening the pool of treatment options. Secondly, as a pull incentive, England's National Health System (NHS) implemented the world's first antibiotic subscription model in April 2022. Pfizer and Shionogi will supply their antibiotics ceftazidime/avibactam and cefiderocol to the NHS for a fixed fee of GBP 10 million a year each.¹⁵ This model is intended to prevent over-prescription. If it is successful, use of this model could help LMICs to demonstrate a financially viable and sustainable market.

Antibiotics and antifungals covered by access strategies in the 2021 Benchmark

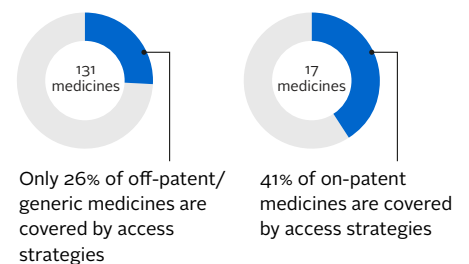

Source: 2021 AMR Benchmark. This analysis assessed the portfolios of 17 companies.

There are three, currently underutilised, approaches that can ramp up access to on-patent antibiotics and antifungals:

1. Mechanisms that make on-patent MDR-TB medicines widely available

The successful development of bedaquiline in 2012 prompted the development of a successful, detailed stewardship model for a novel, on-patent medicine.

Bedaquiline, as well as other on-patent medicines that treat multidrug-resistant or extensively drug-resistant (MDR/XDR) tuberculosis (TB), are exclusively procured and provided via the Global Drug Facility (GDF) Stop TB Partnership. This partnership coordinates the supply of medicines to TB programmes run by national governments with high burdens of this disease.

The partnership also supports in-country stewardship practices and surveillance programmes. As a result, national TB programmes have uninterrupted access to high-quality, affordable medicines while also ensuring that these precious medicines are carefully stewarded. While more needs to be done, more than 140 countries have received TB medicines and diagnostics via the GDF partnership, reaching almost 34 million adults and 2.5 million children since 2011.

MDR-TB medicines are also eligible for the WHO Prequalification process, where WHO assesses whether medicines meet certain standards of quality, safety and efficacy. Prequalified medicines can be purchased by or through international procurement agencies without registration, making them more easily available to patients in LMICs. WHO has expanded the scope of its Prequalification process to products for other diseases, which creates opportunities for companies to also efficiently expand access to antibiotics and antifungals using this process.

2. Local manufacturing and technology transfer are vital but limited

Local manufacturing makes it easier for products to reliably reach people living in a particular country or region, particularly in the face of import restrictions and disrupted supply chains. Disruptions to security of supply have been particularly prevalent in sub-Saharan Africa during the COVID-19 pandemic, where up to 90% of all medicines consumed are imported.¹⁷

Pharmaceutical companies can transfer their technology and expertise to manufacturing partners in LMICs to increase local capacity. This improves access to companies' products while decreasing regions' dependency on international supply chains and reducing the risks of shortages and stockouts.

10 companies support local manufacturing projects across 14 low- and middle-income countries

Of the 17 companies covered by the Benchmark, 10 report they are supporting local manufacturing in at least one of 102 LMICs. This map shows the countries where at least one project is taking place.

● Countries where companies are supporting local manufacturing

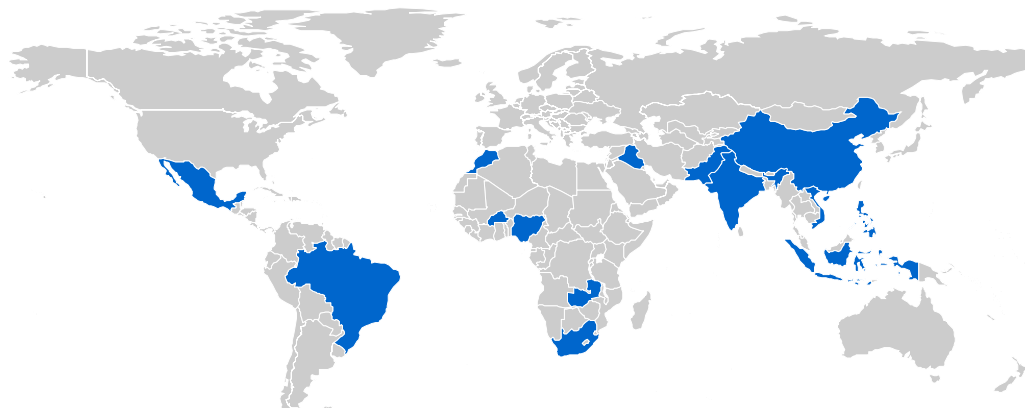

Source: 2021 AMR Benchmark

Despite the opportunity to form local partnerships, few such transfer initiatives exist for both on- and off-patent antibiotics and antifungals. Decisions by companies to transfer their technology depend heavily on the presence of local partners with the right skills and quality standards. Finding suitable manufacturers to produce on-patent products is particularly complex, due to the medicines' novel chemical structures.

How SMEs bring new products to market

Biotechs and small- and medium-sized enterprises (SMEs) are developing the bulk of the pipeline of novel, late-stage antibiotics and antifungals.¹⁶ In general, these companies do not yet have products available on the market and depend on research funding to survive. Yet, due to the lack of a healthy market for new products and the lack of acquisition of SMEs by large pharmaceutical companies, these SMEs must navigate the so-called financial "valley of death," where research funding runs out before financial returns of products kick in. When SMEs struggle to secure resources to complete the development of their product and support its launch, often leading to bankruptcy, this results in the loss of their pipelines of promising products. However, some SMEs are turning to partnerships with local companies in emerging economies, such as China, India and South Africa, to reach worldwide markets.

3. Voluntary licensing agreements to ensure sustainable supply

To allow technology transfer for on-patent products, research-based companies can use (non-exclusive) voluntary licensing, which allows local generic medicine manufacturers to produce and sell on-patent products. However, these licenses are seldomly used for antibiotics and antifungals.

License agreements are more commercially attractive for generic medicine manufacturers when they are exclusive or only a few manufacturers can participate. When this is the case, research-based companies may have more bargaining power regarding the requirements to be included in the license, for example on access, quality of the product, stewardship and proper waste management for production.

However, such exclusivity does not drive competition between generic medicine manufacturers, which means pricing of products might also not be competitive. Affordability of products is further worsened when manufacturers need to warrant appropriate use, compensate low sales volumes with higher prices, and in case the product is difficult and costly to manufacture, as previously seen in the case of delamanid (Delyba[®]), an antibiotic used to treat MDR-TB.^{18,19} In fact, to date, no voluntary licence has been issued yet for a novel antibiotic, other than for delamanid.

In sum, while the market for antibiotics and antifungals is fundamentally unstable with fragile supply chains and tough market conditions, there are factors that can contribute to better access to essential off-patent/generic medicines in LMICs. Insight into local demand, diversifying supply chains and long-term procurement strategies via tenders can mend the go-to-market model for older medicines. On-patent medicines are not introduced at scale because poorer countries often do not have suitable healthcare infrastructure or stewardship measures in place. Yet effective partnerships such as the Global Fund to fight AIDS, Tuberculosis and Malaria, increasing local manufacturing via technology transfer and the use of voluntary licensing can expand access to patented products. The following six case studies include practical examples of how pharmaceutical companies have used access strategies to make both off-patent/generic and on-patent medicines more widely available.

Case studies

Only a handful of cases show tangible ways access was addressed in LMICs.

What are companies doing?

This paper builds on one of the key findings of the 2021 AMR Benchmark, namely that pharmaceutical companies are making limited use of the many ways to improve access to antibiotics and antifungals in low- and middle-income countries (LMICs). Where access strategies are in place, they remain focused on a small set of countries, people and diseases.

In developing this paper, the authors could only identify a handful of examples of ways pharmaceutical companies used access strategies to make off-patent/generic and on-patent antibiotics and antifungals available in LMICs. However, these case studies show that there are tangible steps that companies can take to address access. Using the right combination of access strategies can make a real difference to millions of people if deployed more widely.

These case studies have been drawn from research published in the 2021 AMR Benchmark, as well as from interviews held with companies and experts in the AMR field. It was further informed by sources available in the public domain. Information from these sources was cross-checked directly with companies and their partners to ensure accuracy.

► **Case study 1:**

Metronidazole, Sanofi, Nigeria

► **Case study 2:**

Colistin, Cipla, India

► **Case study 3:**

Flucytosine, Viartis, South Africa

► **Case study 4:**

Liposomal amphotericin B, Cipla, India

► **Case study 5:**

Cefiderocol, Shionogi, LMICs

► **Case study 6:**

Ceftazidime/avibactam, Pfizer, Ghana

CASE STUDY 1

Access to metronidazole via technology transfer and capacity building

Via technology transfer in Nigeria, Sanofi has provided local patients with sustainable access to metronidazole, a much-needed Access antibiotic to treat gastro-intestinal infections

What does this case study show?

Sanofi demonstrates it is possible for pharmaceutical companies to produce products locally to high standards. To successfully transfer technology and build capacity locally, companies must consider factors such as unmet medical needs, clinical guidelines and the time needed to identify and onboard local partners who can ensure product quality.

A ready path to financial returns

In sub-Saharan Africa only Kenya, Nigeria and South Africa have a relatively sizeable manufacturing industry, with several companies producing for local markets and in some cases for export.¹⁷ Supply chains remain international and fragmented, with many raw materials and active pharmaceutical ingredients (APIs) sourced across borders. As a result, Africa produces less than 2% of the medicines it consumes while its population accounts for nearly 17% of the world's population.²¹

In Nigeria, where 70% of medicines are imported,²² Sanofi has performed technology transfers for an off-patent antibiotic called metronidazole (Flagyl®). Since 2008, Sanofi's transfers have allowed local partners to produce metronidazole, a first-line Access antibiotic on the 2021 WHO Model List of Essential Medicines. Metronidazole treats gastrointestinal infections but has wide-ranging use. In Nigeria, it is mostly used for community- and hospital-acquired infections and as a surgical antibiotic prophylaxis.²³ With a market presence in Nigeria, Sanofi embarked on manufacturing products locally to meet its own quality standards. With a population of more than 200 million people,²⁴ the country has a large market and, as metronidazole is relatively easy to produce, offered a ready path to financial returns.

Proactive approach to transferring technology

To produce metronidazole in Nigeria, Sanofi had worked with a local partner since 2008. However, in 2015, Sanofi started partnering with May & Baker, once the subsidiary of a British chemical company that Sanofi had pre-existing links with, and one of the leading producers in Nigeria with Good Manufacturing Practice (GMP) certification from the World Health Organization (WHO). In 2019, two technology transfers were completed that involved upgrading plant production to state-of-the-art manufacturing and Sanofi was issued approved registration by the Nigerian Regulatory Authorities (NAFDAC).

The company's transfers and training have built capacity to implement analytical methods, process validation and production of validation batches, preparation of validation protocols and reporting for pharmaceutical products, and enabled May & Baker's plant to meet GMP quality standards. Annually, May & Baker produces about half a million boxes of metronidazole (tablets and liquid suspension) for the Nigerian market. Its plant produces the antibiotic from active pharmaceutical ingredient (API) stage to final product, with packaging material manufactured locally but raw materials coming from India, China and the United Kingdom .

	Product: Metronidazole (Flagyl®)
	Use: Broad-spectrum Access antibiotic (nitroimidazole class) indicated in prophylaxis and treatment gastrointestinal and parasitic infections.
	Scale: In 2019, intra-abdominal infections (including gastrointestinal infections) alone accounted for around 800,000 deaths associated with antimicrobial resistance (AMR) globally. ¹
	Company: Sanofi
	Partner(s): Pharmaceutical manufacturer, May & Baker Nigeria Plc.
	Country: Nigeria
	Impact: May & Baker produces nearly half a million boxes of metronidazole annually for the Nigerian market. Worldwide, Sanofi sold more than 32 million packs of metronidazole in tablet, injectable and liquid form in 2017. ²⁰

Sanofi demonstrates best practice through continuing support. At first, May & Baker produced metronidazole tablets without coating, which lead to the medicine tasting bitter, discouraging patients from continuing treatment. When the Nigerian government asked for coating to be added, Sanofi sourced a UK supplier, dealt with permissions and regulations, and provided technical support at May & Baker for the coating technology. Sanofi performs annual quality reviews at the May & Baker plant, carries out quality and Health, Safety and Environment (HSE) audits every three years, and makes monthly reviews and quarterly site visits. Through technology transfer and corrective/preventative actions, Sanofi also improved the plant for production of other medicines. To ensure appropriate use of metronidazole, Sanofi does not promote this product to healthcare professionals, as it is strictly sold through distribution partners, and sales volumes are determined by supply-on-demand only.

Nigerian push and pull towards local manufacturing

Since 2019, the Nigerian government has stipulated that importing companies must, for a defined list of essential products, provide an action plan to localise production within 5 years.²⁵ If companies do not manufacture their products locally or through a local partner, they run the risk of losing product registrations.

In 2022, WHO announced that NAFDAC is the fourth African regulatory system that has achieved a high maturity level in WHO classification and is now globally recognised as an effective regulatory system. This status can further boost manufacturing capacity in the country as it ensures medical products entering the market are safe, effective and produced according to international quality standards. For example, Nigeria was chosen as a recipient of mRNA technology by the WHO mRNA Technology Transfer Hub, an initiative that builds capacity in low-and middle-income countries (LMICs) to produce mRNA vaccines.²⁶

Next steps for local production in Nigeria

New challenges have come up in Nigeria with the government's requirement for production by local partners. Although this is a big incentive for pharmaceutical companies to engage in local manufacturing, it also poses risks. Sanofi also sells penicillin, beta-lactams and amoxicillin; for antibiotics that are trickier to make, such as beta-lactams, it may take considerable time to find the right partners, transfer technologies and meet quality standards. If challenges become severe and there is little potential for return on investment, nor guarantees for stewardship, companies may opt to leave the market or not enter it at all. To avoid such outcomes, the government could engage with companies to provide them with enough time to adjust to the new stipulations.

Import of medicines in Africa is much higher than local production

Africa produces less than 2% of the medicines it consumes.



In Nigeria, with a population of over 200 million people, 70% of medicines are imported.

Source: United Nations Africa Renewal, 2017²¹, American Journal of Tropical Medicine and Hygiene, 2020²²

CASE STUDY 2

Access to colistin based on response to expert-signalled demand

Based on clearly defined demand, Cipla was able to provide access to colistin in India. Colistin is an antibiotic used to treat multidrug-resistant infections in the lower respiratory and urinary tract.

What does this case study show?

This case study shows that generic medicine manufacturers can work with experts to determine and respond to demand in a particular country or region. Colistin is a Reserve product, but the same principle applies to Access antibiotics, many of which are older and also off-patent.

The need for older, generic antibiotics

Some older, generic antibiotics may no longer be produced or supplied by companies because of a lack of expected profit and a lack of awareness of or misunderstood demand, even though these medicines are still clinically useful. Most older antibiotics are produced by multiple companies, yet those living in low-and middle-income countries (LMICs) have very little access to these products since they are filed for registration in only 5 out of 102 LMICs on average.⁸

One example of how older antibiotics can be made available is colistin, which is an off-patent antibiotic discovered in the 1940s. Since colistin can have side effects related to toxicity in the kidneys, it was largely abandoned in the 1970s due to safer alternatives. As resistance to other commonly used antibiotics increased in the 1990s, colistin was then seen as an alternative for the treatment of multidrug-resistant bacteria. It is now listed on the 2021 WHO Model List of Essential Medicines in the Reserve group for the treatment of multidrug-resistant pneumonia and urinary tract infections. The AMR Benchmark recommends that this antibiotic is made available by companies in LMICs, provided there are good stewardship practices in place to prevent toxicity and excessive use and reduce the risk of driving resistance.







Responding to local demand and ensuring stewardship

In 2007 in India, an infectious disease expert from a large private hospital made a direct approach to the generic medicine manufacturer Cipla to request access to colistin at their hospital after hearing the company's global medical officer speak at a private hospital event. At the time, the 50-year-old antibiotic was little used in India except in private hospitals, which imported the medicine from the UK to treat individual patients.

Cipla launched its own survey in India and found high levels of unmet medical need. It then contacted an active pharmaceutical ingredient (API) supplier in Denmark and discussed with regulatory authorities in India how it might proceed to make the product available. High unmet medical need obviated the need for clinical trials, so Cipla conducted a Phase IV pharmacokinetic study and one effectiveness and safety study. After successful trials, Cipla introduced colistin to the Indian market. Fifteen years later, colistin is now widely available for human health in India and supplied by many different companies, while still being an essential target for stewardship measures.

To ensure appropriate use of colistin, Cipla has supported education on treatment guidelines for healthcare professionals and provided guidance on susceptibility testing – analysing pathogens' vulnerability to antimicrobial medicines – to monitor the use of colistin in Indian ICUs. Cipla also supported an educational initiative titled Because Kidney Matters on minimising kidney toxicity in patients that receive colistin.

Cipla repeated this formula, proving how effective responding to demand signalled by local experts is, when it answered a similar call to make (intravenous) fosfomycin available. Fosfomycin is a Reserve antibiotic, like colistin, and is primarily used to treat lower urinary tract infections. Cipla now sells this product in India, manufactured by a third party.

	Product: Colistin
	Use: Colistin, administered as an injection, is an off-patent Reserve antibiotic listed on the 2021 WHO Model List of Essential Medicines used to treat multidrug-resistant Gram-negative bacteria, including lower respiratory tract and urinary tract infections.
	Scale: In 2019, lower respiratory infections accounted for more than 1.5 million deaths associated with antimicrobial resistance (AMR) globally. ¹
	Company: Cipla
	Partner(s): Infectious disease specialists, Indian regulatory authority
	Country: India
	Impact: In 2020, Cipla distributed colistin to 500 Indian hospitals, treating 20,000 patients in India per month.

CASE STUDY 3

Access to flucytosine via partnerships and a clinical access programme

Because of extensive partnership and a successful access programme, patients in South Africa with cryptococcal meningitis (CM) have access to flucytosine, a much more effective treatment than a previous standard of care.

What does this case study show?

With the flucytosine access programme, several stakeholders played an important part to ensure local availability to flucytosine despite an initial lack of registration by companies. Even though manufacturers were not yet ready to file for registration, action came through a clear push from South African specialists who wanted to ensure patients could access better treatment.

A new combination to treat CM

Flucytosine is a generic product with huge relevance for treating disease in Africa. CM is one of the leading causes of death in people with advanced HIV/AIDS, leading to about 180,000 deaths per year globally, mostly in Africa.²⁷ Undiagnosed and untreated, the disease is fatal. In February 2020, the Lancet Infectious Diseases journal suggested almost 140,000 deaths occur annually in sub-Saharan Africa as a result of CM.²⁸ Yet, more than seven in ten people will survive with early, optimal treatment.







Results from an Antifungal Combinations for Treatment in Africa (ACTA 2018) clinical trial showed use of flucytosine (versus fluconazole) in combination with amphotericin B reduced deaths due to CM by about 40%.²⁹ This strengthened calls to increase access to the product as a “humanitarian, as well as a scientific imperative.”³⁰ Flucytosine is now a life-saving component of new WHO-recommended preferred and alternative treatment regimens for CM and it has received WHO Prequalification.

Many HIV-positive patients living in low- and middle-income countries (LMICs) with CM will not receive the right therapy, if any at all. In sub-Saharan Africa and elsewhere, where flucytosine has been unavailable, healthcare professionals may combine amphotericin B with fluconazole or give fluconazole on its own, which is never recommended due to inferior treatment outcomes.

Barriers to access

Flucytosine was developed in 1957 and has been off patent for decades, but its production costs remain high, which leads to barriers in access. Reasons for the delay in providing flucytosine to those who need access to it are interconnected and complex. At government level, the product is widely seen as unaffordable. Among healthcare professionals in Africa, knowledge about flucytosine/amphotericin B is low, with few healthcare providers likely to choose flucytosine over fluconazole. On top of that, standard formulations of flucytosine – four oral doses per day, with tablets often needing to be crushed and given by nasogastric tube if a patient has a reduced level of consciousness – are difficult to use in low-resource settings.

Generic medicine manufacturers, expecting low demand and seeing little opportunity for profit or even return, have been reluctant to invest time and resources to file for registration, scale up manufacturing and distribution operations, and make this product available to populations in need.

	Product: Flucytosine
	Use: An antifungal medicine used to treat HIV-associated cryptococcal meningitis (CM) in combination with liposomal or deoxycholate amphotericin B.
	Scale: CM is one of the leading causes of death in people with advanced HIV/AIDS, leading to about 180,000 deaths a year, mostly in Africa. ²⁷
	Company: Viatris
	Partner(s): CHAI, MSF, Unitaid, Global Fund, PEPFAR, FHI360, Strides, DNDI, FARMOVS
	Country: South Africa
	Impact: Viatris has supplied flucytosine to 1,595 patients in South Africa as part of this programme.

Cryptococcal meningitis (CM) is a leading cause of death in people with HIV/AIDS

CM is one of the leading causes of death in people with advanced HIV/AIDS, leading to about 180,000 deaths globally per year, 140,000 of which in sub-Saharan Africa.



75% of HIV patients who die of CM live in sub-Saharan Africa

Source: Ending Cryptococcal Meningitis Deaths by 2030 - Strategic Framework²⁷

In South Africa, a country with a high HIV prevalence rate, flucytosine was registered by the South African Health Products Regulatory Agency in December 2021. Before that, the government's so-called Section 21 exemption allowed clinicians to obtain unregistered flucytosine for specific patients.³¹ This route supports patients on a case-by-case basis, but it does not ensure broad access to unregistered medicines.

Birth of a clinical access programme in South Africa

Following the successful conclusion of the clinical trial for the combination of flucytosine with amphotericin B, pressure from clinicians in South Africa led to the establishment of a clinical access programme in 2018, aiming to bridge access gaps. In the ongoing programme, Viatris is involved as supplier and Unitaid has provided funds through a Clinton Health Access Initiative (CHAI) grant in order to ensure its continuation. Médecins Sans Frontières (MSF) initially set up the programme to procure and supply flucytosine to South Africa's tertiary public sector hospitals before the product became widely available, after urging of the Southern African HIV Clinicians Society and with support from South Africa's National Department of Health.

Flucytosine has now been approved as part of the preferred treatment regimen for CM in the South African National Essential Medicines List and in 2020 Viatris filed for registration in South Africa, making more widespread uptake possible. Registration was granted in December 2021.

Access programmes as transitional mechanisms

This access programme can be seen as a transitional mechanism to facilitate wider access to medicine and to produce evidence of a market and a product's importance to public health. Access programmes can demonstrate market potential and motivate companies to file for registration, such as previously done for rifabutin for tuberculosis, direct acting antivirals for hepatitis C, and delamanid for drug-resistant tuberculosis. As such, programmes like this may form part of the solution to dismantle a vicious cycle of perceived low demand, although they should not be seen as an alternative to sustainable widespread access to antibiotics and antifungals.

New developments for other countries

There are some new developments that can improve access to flucytosine in other LMICs.³² Through the Global Fund, the U.S. President's Emergency Plan for AIDS Relief (PEPFAR) and FHI360, a non-profit human development organization, Viatris underwent an independent dossier evaluation to allow global procurement prior to receiving WHO Prequalification.

Viatris also worked with the Drugs for Neglected Diseases initiative (DNDi) to develop a sustained-release formulation of flucytosine to facilitate twice daily dosing instead of the current four times daily. In early 2022, new Phase I clinical trials of various prototypes of this modified release formulation were launched with FARMOVS, a clinical research organisation affiliated to the University of the Free State in South Africa, with the aim to strengthen local capacity. Phase II studies of the most favourable prototype from Phase I are planned for Tanzania and Malawi.

Coordinating with partners to manufacture the product in India, Viatris reduced the price from USD 110 to USD 75, and increased capacity to manufacture more quickly. Viatris also worked with partners to allow procurement prior to WHO Prequalification. Countries making use of this process include Botswana, Lesotho and Nigeria. CHAI reports that Viatris received WHO Prequalification and after a quality audit, Strides, another generic medicine manufacturer, gained FDA approval. The company has yet to file for registration in South Africa.

CASE STUDY 4

Access to liposomal amphotericin B in response to a government request







Due to an effective response to a government request, more patients in India were able to access liposomal amphotericin B during the COVID-19-related mucormycosis epidemic in 2021.

In 2021, a mucormycosis epidemic broke out in India. Multiple risk factors contributed to this epidemic: a high background prevalence of mucormycosis in India, undiagnosed or poorly controlled diabetes, COVID-19–induced immune dysregulation and therapies such as steroids, which cause immune suppression. The disease reached an epidemic stage while many patients could not access basic healthcare due to the COVID-19 pandemic surge.

In response to a request from the Indian government, Cipla rapidly scaled up manufacturing of liposomal amphotericin B and quickly found contract manufacturers to scale up manufacturing drastically. The contract manufacturers temporarily stopped manufacturing other products to prioritise this product. This case shows that if pharmaceutical companies and governments work together, they can step up to address issues that are time-sensitive and high demand in nature.

Black fungus in India

Mucormycosis is a very rare fungal infection with an overall mortality rate of approx. 50%.³⁴ It is caused by exposure to mucor mould which is commonly found in air, soil, plants, compost and animal dung.³³ In India, prevalence of mucormycosis is estimated as affecting 140 people in a population of one million. Mucormycosis is difficult to treat. It may require antifungal therapy as well as surgery to remove the infected tissue. Liposomal amphotericin B is the treatment of choice for both mucormycosis and COVID-19-related mucormycosis.

	Product: Liposomal amphotericin B
	Use: Liposomal amphotericin B can be used to treat mucormycosis, also called 'black fungus' colloquially. The product has a better safety profile than amphotericin B, a version of the medicine without the drug delivery method called liposome.
	Scale: In India, prevalence of mucormycosis is estimated to affect 140 people per one million. ³³
	Company: Cipla
	Partner(s): Government of India, contract manufacturers
	Country: India

In India prevalence of black fungus is estimated as 140 per million population. The mortality rate is approx. 50%.



Approx. 50% of people infected with black fungus will die

Source: *Clinical Infectious Diseases*, 2021³²

CASE STUDY 5

Access to cefiderocol via innovative partnership

A partnership initiated by Shionogi is the first step to scale up the global production and distribution of cefiderocol to meet global demand and provide patients access to a novel antibiotic that treats multidrug-resistant infections.

A novel antibiotic that treats deadly pathogens







Shionogi, a research-based company based in Japan, produces cefiderocol under the brand name Fetroja®/Fetroja®. This siderophore cephalosporin antibiotic was first approved by the United States Food and Drug Administration in 2019 and uses a novel mechanism of action against aerobic Gram-negative bacteria. It is included in the 2021 WHO Model List of Essential Medicines as a Reserve antibiotic with the potential to treat antibiotic-resistant infections such as complicated urinary tract infections (cUTI), hospital-acquired bacterial pneumonia and ventilator-associated bacterial pneumonia (HABP/VABP).³⁵ Specific to cefiderocol is its activity against, among others, drug-resistant *P. aeruginosa* and *A. baumannii*, causing urinary tract, intestine, blood and pneumonia infections in patients.³⁶ These two pathogens belong to the most deadly, drug-resistant pathogens worldwide, responsible for 216.600 deaths and associated with more than 700.000 deaths in 2019.¹

For smaller companies with limited manufacturing capacity, there are significant challenges in making novel antibiotics accessible in low-and middle-income countries (LMICs). Shionogi reports high cost of goods and struggles to scale up production. The manufacture of cefiderocol is complex, requiring lyophilization and purification processes. Global partners can bring production costs down and production to scale, but technology transfers require thorough preparation. The biggest hurdle lies in the investment of time and resources to find large contract manufacturing organisations (CMO) with the capability to master complex, high-volume production and to spur roll-out in LMICs while ensuring appropriate use.

A pioneering model for access through partnership

Shionogi only manufactures in Japan and, unlike large research-based companies, lacks a footprint or expertise in local markets. Having recognised the challenge to make its novel antibiotic available in LMICs by itself, the company actively sought partners to improve access. In July 2021, it announced a Memorandum of Understanding (MoU) with the Global Antibiotic Research and Development Partnership (GARDP) and the Clinton Health Access Initiative (CHAI) to accelerate access to cefiderocol in LMICs.³⁷

Shionogi's first-in-kind approach for increasing access to antibiotics has catalysed a still-nascent collaboration. GARDP aims to provide affordable and sustainable access, promoting appropriate use and stewardship of antibiotics (ensuring suitable plans are in place), while CHAI will guide on how to reach patients in need via market-shaping, in-country adoption of the product and programme delivery.³⁸ The next major step will be to form a partnership with a large manufacturer.

	Product: Cefiderocol (Fetroja®/Fetroja®)
	Use: An injectable antibiotic active against aerobic Gram-negative bacteria to treat infections with limited treatment options, including complicated urinary tract infections (cUTI), hospital-acquired bacterial pneumonia and ventilator-associated bacterial pneumonia (HABP/VABP). ³⁵
	Scale: Cefiderocol is active against carbapenem- and multidrug-resistant bacteria including <i>P. aeruginosa</i> and <i>A. baumannii</i> , which accounted for more than 700,000 deaths associated with antimicrobial resistance (AMR) in 2019 globally. ¹
	Company: Shionogi & Co, Ltd
	Partner(s): CHAI, GARDP
	Country: LMICs

Drug-resistant *P. aeruginosa* and *A. baumannii* are two of the deadliest pathogens

Together responsible for
216.600
 deaths and associated with more than
700.000
 deaths in 2019

Source: the GRAM report¹

One way for Shionogi to increase access to cefiderocol is to follow the example of the licensing and technology transfer agreement Otsuka has made with Viartis to produce and distribute a generic version of delamanid (Delytba®) to treat active, multidrug-resistant tuberculosis (MDR-TB).³⁹ Where delamanid is procured via the Global Drug Facility (GDF) Stop TB Partnership and has a high demand, a global collaboration for antibiotics is lacking, which makes global access to affordable antibiotics even more difficult.

CASE STUDY 6







Access to ceftazidime/avibactam via partnership and patient assistance programme

Through partnering with a local health-tech company, Pfizer has enabled patients in Ghana to better afford ceftazidime/avibactam, a much-needed Reserve antibiotic to treat multi-drug resistant infections.

Making an on-patent antibiotic affordable in Ghana

There are several steps a company needs to take to make an on-patent product accessible, including filing for registration, supporting stewardship and generating return on investment. On top of that, companies need to consider affordability since patients in low- and middle-income countries (LMICs) typically pay out of pocket, which often makes novel antibiotics unaffordable for those who need them.

To counteract this problem, Pfizer set up patient assistance programmes with local partners in Ghana, including the health tech company mPharma. This partnership led to lower distribution costs, which typically drive up overall costs, as local distribution in LMICs can be challenging. Together with price discounts provided by Pfizer and mPharma, this resulted in 50% patient savings. By further providing patients with micro financing up to 60 days, ceftazidime/avibactam has become more affordable to those who urgently need it. Pfizer plans to implement a similar programme in Kenya in 2022. However, finding reliable, local partners that can implement such patient assistance programmes can be challenging and therefore a limiting factor for bringing this practice to scale.

	Product: Ceftazidime/avibactam (Zavicefta™)
	Use: An injectable antibiotic active against aerobic Gram-negative bacteria to treat infections with limited treatment options, including complicated intra-abdominal infections (cIAI), complicated urinary tract infections (cUTI) and hospital-acquired pneumonia (HAP), including ventilator-associated pneumonia (VAP).
	Scale: In 2019, intra-abdominal infections alone accounted for around 800,000 deaths associated with antimicrobial resistance (AMR) globally. ¹
	Company: Pfizer
	Partner(s): mPharma, a Ghana-based health tech company
	Country: Ghana

Pfizer's pledge to make on-patent medicines and vaccines available at cost in 45 LMICs

Pfizer launched the initiative "An Accord for a Healthier World" in May 2022. With the Accord, Pfizer aims to provide 23 of its on-patent medicines and vaccines on a not-for-profit basis to 45 LMICs, including all 27 low-income countries (LICs).⁴⁰ The antibiotic ceftazidime/avibactam is part of the Accord portfolio and Pfizer announced it will include all future medicines within the Accord agreement.

Pfizer has committed to partnering with local health officials of participating countries and will seek further global and local partnerships to improve diagnosis, professional healthcare education and infrastructure, and supply chain management. Within the initiative, partners and participants will also work to identify ways to improve regulatory pathways (such as registration) and procurement processes to reduce the time it takes to make medicines and vaccines available. Pfizer will pilot the initiative in Ghana, Malawi, Rwanda, Senegal and Uganda, to gather learnings before rolling out to the remaining 40 countries.

DISCUSSION

Collaboration between stakeholders is a key ingredient

This paper has mapped out the chronic issues that are limiting access to essential antibiotics and antifungals in low- and middle-income countries (LMICs) and described strategies that pharmaceutical companies, governments, procurers and other (local) partners can use to increase appropriate access. The case studies in this paper have demonstrated how different stakeholders can take action - they are isolated examples that can become standard practices so that patients everywhere receive the right treatment at the right time. The following discussion elaborates on the key strategies to expand access to both off-patent/generic and on-patent antibiotics and antifungals.

Supporting local manufacturing and technology transfers in LMICs

Local manufacturing of antibiotics and antifungals in LMICs increases access to essential medicines, while reducing the risks of shortages and stockouts. For example, in this paper's first case study, Sanofi responded to local demand and set up local production of metronidazole in Nigeria via capacity building and technology transfer. This practice shows that, with an existing infrastructure and reliable local partners, it is possible for pharmaceutical companies to build local manufacturing capacity for much-needed Access antibiotics. However, unlike Nigeria - home to more than 200 million people²⁴ - most LMICs have smaller populations and lower demand. In these regions, rather than serving one country with one local manufacturing plant, building regional manufacturing hubs that serve several countries has greater potential to meet the threshold of viability, expand limited manufacturing capacity, and make a financially sustainable impact in underserved regions.

Besides pharmaceutical companies, governments can also spur the development of regional manufacturing hubs by promoting intra-continental trade. Trade between African countries, for example, accounts for only 15% of the continent's total trade, resulting in a high dependency on markets beyond Africa.⁴¹ Initiatives such as the Economic Community of West African States (ECOWAS) Trade Liberalization Scheme and the Africa Continental Free Trade Agreement seek to unite the typically small and fragmented African markets by addressing challenges in export, regulatory requirements and logistical issues.

International health organisations such as the World Health Organization (WHO) can also offer solutions. In 2021, WHO initiated the mRNA vaccine technology transfer hub in South Africa to build capacity for mRNA vaccine production across LMICs.⁴² Six African countries - Egypt, Senegal, Kenya, South Africa, Tunisia and Nigeria - of 15 countries in total have emerged as the first recipients of the mRNA technology transfer.⁴³ Besides local manufacturers and WHO, partners of the initiative include the Medicines Patent Pool (MPP), Access to COVID-19 Tools (ACT) Accelerator, COVID-19 Vaccines Global Access (COVAX), African Union, and the Africa Centres for Disease Control and Prevention (Africa CDC). A similar programme needs to be considered to responsibly catalyse regional manufacturing of essential antibiotics and antifungals in LMICs.

Identifying the right public-health partners

Pharmaceutical companies, international health organisations and governments can partner to procure essential antibiotics and antifungals or fund and implement access programmes. A good example is the case study involving the clinical access

IN BRIEF

- ▶ Lack of access to antibiotics and antifungals drives AMR, yet there is a stark lack of access initiatives.
- ▶ Local manufacturing reduces underserved regions' dependency on fragile supply chains.
- ▶ Partnerships between different stakeholders is a key denominator to spur action.
- ▶ Clarity on demand for specific products can prompt companies to strengthen supply chains.
- ▶ Research-based companies can set up early access programmes for novel antibiotics to close the gap between first global launch and filing for registration in specific LMICs.
- ▶ Companies should proactively communicate with regulators to make registration processes faster and more efficient.

programme in South Africa for the antifungal flucytosine. International health organisations set up a partnership with a generic medicine manufacturer to ensure access to flucytosine, even though the medicine had not been not filed for registration in any country in Africa. Viartis responded to the call for action and supplied the essential antifungal. The partnership was funded by the global community supporting people living with HIV/AIDS, as flucytosine is used to treat HIV-associated cryptococcal meningitis (CM).

Another example of partnership is the technology transfers Sanofi has set up since 2008 with local manufacturing partners to produce metronidazole in Nigeria. In 2019, local manufacturing in this country got a new impulse with a requirement for pharmaceutical companies by the Nigerian government. Companies that want to market antibiotics in Nigeria have to locally manufacture these products, either through a partnership with a local manufacturer or by setting up local manufacturing plants. While this policy aims for Nigeria to become less dependent on the international antibiotic supply chain, it can also result in multinational companies exiting the Nigerian market. Therefore, flexibility is warranted and alignment between the government and companies is key to ensure the migration to local manufacturing is realistic and timely.

In the fragmented market for on-patent antibiotics, partnerships between companies, international health organisations and governments can be a promising way forward to increase appropriate access to novel antibiotics in LMICs. An example is the case study where research-based company Shionogi sought out partnerships to reach more patients in LMICs with their on-patent antibiotic cefiderocol. Shionogi initiated a Memorandum of Understanding (MoU) with Clinton Health Access Initiative (CHAI) and Global Antibiotic Research and Development Partnership (GARDP) that aims to provide affordable and sustainable access, while also promoting appropriate use.

Another example is Pfizer's recently launched "Accord for a Healthier World" initiative. With the Accord, Pfizer aims to provide its current and future on-patent medicines and vaccines to 45 low- and lower-middle-income countries on a not-for-profit basis. Pfizer has committed to partnering with local governments and international health organisations for implementation. Alongside making medicines rapidly available, the company intends to strengthen the local health systems of participating countries with public and private partners. Sharing the burden of costs and tasks in the production and the delivery of supplies is a critical first step towards overcoming health inequity for the poorest countries in the world.

Finally, the Global Fund to Fight AIDS, Tuberculosis and Malaria and other international health organisations have partnered with companies to address HIV/AIDS, tuberculosis and malaria. Despite being donor-driven and less sustainable in the long term, these partnerships were able to consistently implement access and stewardship programmes for essential medicines. Access to antibiotics and antifungals should be defined as a priority on the global health agenda in order to facilitate similar, effective partnerships. Recently, initial steps were taken to organise a global partnership specifically for antibiotics called SECURE (see box).

First steps towards a global antibiotic access and stewardship facility

SECURE, an initiative developed by GARDP and WHO, aims to expand access to essential antibiotics in LMICs by establishing relevant product portfolios of on- and off-patent antibiotics per participating country, based on public health needs.⁴⁴ The market-driven and sustainable portfolios will be financed by development agencies, philanthropic institutions and the LMICs themselves. The LMICs will be actively involved to ensure appropriate use of the antibiotics that are provided. A 3 to 4 year-long pilot is expected to start at the end of 2022 to demonstrate the value of this novel, global antibiotic access and stewardship facility.

Defining local demand to introduce generic medicines

There is a need for global, regional and national efforts to measure and map demand for essential antibiotics and antifungals, especially for first-line treatments. Lack of clarity on local demand is one of the reasons pharmaceutical companies do not have the confidence to introduce or reintroduce older, off-patent/generic products into LMIC markets. If demand from governments and (pooled) procurement agencies is signalled strongly and clearly, this will trigger companies to act by appropriately expanding access to essential products in those countries. Governments and (pooled) procurement agencies can signal demand in multiple ways.

Governments can generate information on which antibiotics and antifungals are being used in their countries and share insights on local resistance patterns through surveillance of consumption and resistance. This in turn can provide clarity and demonstrate local demand. Once surveillance data has been gathered, demand can be defined in national policies such as Standard Treatment Guidelines and/or National Essential Medicines Lists. Companies can use these policies to anticipate and meet the expected local demand. Furthermore, international health organisations such as CHAI, Médecins Sans Frontières (MSF) and the Pan American Health Organization (PAHO) have the potential to expand access to antibiotics and antifungals – more than they are already doing – by consolidating demand for multiple countries through pooled procurement mechanisms, which can encourage companies to respond by increasing supply.

Once pharmaceutical companies understand demand, the next step is for them to commit to meeting the demand with uninterrupted supply of high-quality and safe products. To encourage supply security, procurement agencies can include continuous supply as an important criterium in tenders, in order to ensure diversity of reliable suppliers and reduce dependency on one or few suppliers.

Two case studies in this paper show that signalling demand helps to increase access to essential products. For example, in the case study involving the antifungal flucytosine, the Southern African HIV Clinicians Society raised awareness for an unmet medical need and recognised the opportunity for funding, since the product can be used to treat HIV/AIDS patients. Another example is the case study where healthcare professionals in India signalled a high unmet medical need for the antibiotic colistin to generic medicine manufacturer Cipla.

Making on-patent products available through license agreements and access programmes

A viable way to incentivise research-based companies to ensure access to on-patent products is to achieve a financially healthy market, whereby companies are reasonably assured of a sustainable business. However, there are several actions that companies and governments can take before this happens in order to increase access to on-patent, essential antibiotics. These include voluntary licensing, access partnerships and early access programmes.

As voluntary licensing may not be widely suitable for on-patent antibiotics and antifungals due to low sales volume expectations and restrictive use measures, license agreements can put heavier focus on other strategic considerations, such as technology transfer, stewardship, and expansion of production into different geographical regions. Biotechs or small- and medium-sized enterprises (SMEs) that are developing new antibiotics are already exploring this approach.¹⁶

Research-based companies can set up early access programmes to make not yet or recently registered products available in places with dire need. Improved value assessment tools for novel antibiotics, such as the Health Technology Assessments (HTA) used by governments and procurement agencies, can further support the launch of novel medicines in LMICs. In the meantime, generic medicine manufacturers do not have to wait to introduce essential novel antibiotics to the poorest

countries via license agreements. Many large research-based pharmaceutical companies, such as GSK, MSD and Pfizer, have pledged not to file and/or enforce patents in Least Developed Countries (LDCs), taking away the barrier for generic medicine manufacturers to increase appropriate access. As a result, generic medicine manufacturers have an opportunity to develop, manufacture and market products such as ceftaroline (Zinforo®), ceftolozane/tazobactam (Zerbaxa®) and ceftazidime/avibactam (Zavicefta™) in LDCs while bearing in mind appropriate use. To date, no such example has been reported.

Harmonising registration across regions

Filing for registration is the first step in providing access to essential antibiotics and antifungals, whether the products are off- or on-patent. One of the ways that stakeholders can create favourable conditions for pharmaceutical companies to increase registration is through harmonisation of regulatory processes. Local regulatory bodies can align the registration processes between countries in the same region to enable swift access to generic products. On top of that, regulatory bodies and WHO can raise awareness of collaborative registration procedures (CRP), such as via mutual recognition procedures, among pharmaceutical companies. Companies can then make use of CRP to file for registration in LMICs, especially after a medicine has already been approved by a stringent regulatory authority such as the United States Food and Drug Administration or European Medicines Agency.

Companies need to be proactive and enter conversations with regulatory bodies to identify opportunities for improving the way of working and communicate about efficiencies in the registration process to speed up procedures. In the case of novel treatments or new indications for existing treatments, companies can set up early access programmes to close the access gap between clinical trials and filing for registration, since it may take years for regulatory bodies to approve a product.

Conclusion

The cases in this paper, in which pharmaceutical companies addressed local availability to antibiotics and antifungals, show that collaboration and partnerships between different stakeholders are key denominators to spur action. A lack of appropriate access to essential antibiotics and antifungals is an urgent and significant issue in antimicrobial resistance (AMR) as it drives resistance, yet there is a stark lack of access initiatives linked to specific products and populations being run by the pharmaceutical companies manufacturing these medicines.

All stakeholders need to step up and explore every opportunity within their capabilities to support and accelerate industry efforts, integrating them within their broader AMR responses. The recommendations in the next section show what each stakeholder can do to contribute to expanding appropriate access to essential antibiotics and antifungals in LMICs, for patented as well as generic products. This may include using multiple access strategies for the same products (see “How can pharmaceutical companies expand access?” and Appendix), but most importantly, stakeholders need to work in partnership.

Recommendations

Research-based pharmaceutical companies

- Ensure that low- and middle-income countries (LMICs) have access to on- and off-patent antibiotics and antifungals by applying a variety of access strategies such as registration, technology transfers and voluntary licensing.
- Pursue collaborations with partners to expand access to on- and off-patent antibiotics and antifungals in LMICs.
- Build regional manufacturing hubs in countries where there is already a local presence or portfolio matching market opportunity by finding reliable local partners.
- Commit to not file or enforce patents in Least Developed Countries (LDCs), low-income countries (LICs) and middle-income countries (MICs).
- Set up early access programmes after completion of successful clinical trials to fill the access gap before registration of products is approved.

Generic medicine manufacturers

- Ensure that LMICs have access to generic versions of antibiotics and antifungals, depending on demand in these countries, by introducing relevant products in case of a high unmet medical need as defined by national health authorities and relevant national policies such as Standard Treatment Guidelines.
- Enable production of more generic versions of off-patent antibiotics and antifungals by participating in voluntary licensing when originator companies offer the opportunity.
- Build regional manufacturing hubs in countries where there is already a local presence or portfolio matching market opportunity by finding reliable local partners.
- Develop, manufacture and market essential patented antibiotics and antifungals in those countries where the originator company committed to not file or enforce patents.
- Apply for WHO Prequalification where relevant.

Governments

In low- and middle-income countries:

- Define demand in the country for specific antibiotics and antifungals by including these products in policies such as Standard Treatment Guidelines and/or National Essential Medicines Lists.
- Ensure that appropriate use and stewardship guidelines are part of Standard Treatment Guidelines and that WHO's Model List of Essential Medicines and AWaRe classification are used appropriately.
- Set up surveillance systems to monitor the resistance and consumption of antibiotics and antifungals and ensure access to the right diagnostics. If there are financial barriers, explore options for investments such as from the World Bank or high-income countries (HICs).
- Financially support and incentivise the creation of local manufacturing hubs for antibiotics and antifungals, including active pharmaceutical ingredients (APIs).
- Invest in intra-continental trade agreements and IP policies, such as the Economic Community of West African States (ECOWAS) Trade Liberalization Scheme and Africa Continental Free Trade Agreement, to streamline trade and logistics of antibiotics and antifungals for small and fragmented markets.
- Utilise Collaborative Registration Procedures (CRP) where possible.

In high-income countries:

- View antimicrobial resistance (AMR) as a global health security issue. Governments can take a collaborative, balanced approach between Ministries of Health, Finance and International Development to address AMR.
- Ensure a viable market for pharmaceutical companies developing new products by implementing payment models that separate payment from sales volume, for example through upfront market entry payment or a subscription style model following the England's National Health System (NHS).¹⁵

Regulatory bodies

- Invest in regulatory harmonisation schemes, such as collaborative registration procedures or mutual recognition procedures, to make it easier, faster and cheaper for pharmaceutical companies to file for registration within multiple countries at the same time. Raise awareness about these types of schemes so they can be better utilised by companies.
- In case of high unmet medical needs for specific products, engage with pharmaceutical companies to define and generate the data needed to file for registration.

Procurement agencies

- Consider security of supply as an important criterium in national and pooled procurement processes on top of the lowest price in tenders. Use innovative Health Technology Assessments (HTA) to assess the value of antibiotics and antifungals to society, rather than for individual patients.
- Collaborate with other procurement agencies to estimate pooled demand and communicate estimates to the pharmaceutical industry.

International health organisations

- Partner with local governments and pharmaceutical companies to ensure access to antibiotics and antifungals in LMICs in case of high unmet medical needs by procuring medicines and funding or implementing access programmes.
- Build local manufacturing hubs by identifying local partners, including pharmaceutical companies, governments and other international health organisations, suitable for manufacturing and rollout of antibiotics and antifungals in LMICs.
- Raise awareness for WHO's Prequalification process, so that more pharmaceutical companies submit relevant antibiotics and antifungals for Prequalification, and support WHO's Expression of Interest process, which requests submissions from companies when their products have great public health value.

Healthcare professionals

- Follow Standard Treatment Guidelines to ensure antibiotics and antifungals are prescribed and used appropriately.
- Help define demand for specific antibiotics and antifungals within your country so these can be communicated in national healthcare policies.

APPENDIX

Access strategies

Access Strategy	Definition	Context	Company Example
Capacity Building	The company forms partnerships with local stakeholders to increase capacity (e.g. by training of staff or obtaining equipment and other necessary resources) in order to strengthen the supply chain.	Lack of capability and training are significant challenges. Companies that demonstrate best practice often partner with others, and/or open their own offices locally. They also work with other stakeholders (such as governments and NGOs) to plan transfers of technology to enable products to be made sustainably.	Company: Sanofi Since 2008, Sanofi has been involved in capacity building in Nigeria to locally produce the Access antibiotic metronidazole. In 2019, two technology transfers were completed that involved upgrading plant production to state-of-the-art manufacturing and Sanofi was issued by the Nigerian Regulatory Authorities (NAFDAC).
Early Access Programme	An Early Access Programme is a pathway allowing patients to access medicines that are yet unregistered in a country. These programmes typically include medicines for serious or life-threatening diseases when there are no other treatment options available, until marketing authorisation has been granted.	The transition from Phase III clinical trials demonstrating the efficacy of a medicine to widespread access in routine-care settings can be slow and tortuous. ³⁰ Early Access Programmes are also known as compassionate use and named patient programmes. ⁴⁵	No examples to disclose.
Equitable Pricing Policy	A targeted pricing strategy, which aims at improving access to medicines and vaccines for those in need by taking affordability for individuals and healthcare systems into account in a manner that is locally appropriate. This means that prices are set within the ability of specific populations to pay, with reference to a range of socioeconomic factors.	Equitable pricing strategies are at the heart of patient-oriented business operations. Such strategies need to be sustainable in the long term for both the pharmaceutical companies and the patients to ensure maximum patient reach across the income pyramid. In this way, companies can provide personalised, income-tailored support based on intra-country pricing solutions and economic conditions by focusing on the needs of local populations and integrate access strategies into the delivery of their health products.	Company: GSK GSK applies equitable pricing to all its off-patent products, devolving pricing decisions to the company's regional General Managers. They can negotiate low inter-country access prices to secure a broader reimbursement in public markets and by capitalising on excess stock opportunities to sell its products at a discount.
Patient Assistance Programme	Patient assistance programmes are defined as programmes initiated by pharmaceutical companies that provide financial assistance or free-of-charge medicines for a defined patient population with limited ability to pay.	In the case of on-patent medicines and vaccines, companies hold the key to access. Patient assistance programmes are not sustainable in the long-term but do take into account affordability to help ensure fast access to new medicines in low- and middle-income countries (LMICs), acting as a shortcut to innovative and needed medicines and vaccines.	Company: Viatris Product: Pretomanid (Dovprela) Viatris offers pretomanid (Dovprela) to up to 40 eligible patients per year in every country where it is not registered, available for free or on par with GDF access pricing. Low- and lower-middle-income countries will be offered a price similar to that of the GDF and Viatris will expand the programme if demand increases.

Access Strategy	Definition	Context	Company Example
Pooled Procurement	Pooled procurement is the formal arrangement where financial and nonfinancial resources are combined across different purchasing authorities to create a single entity for purchasing medicines or vaccines on behalf of individual purchasing authorities. Pooled procurement can be managed through a third party such as UNICEF, the Stop TB Partnership, GDF or PAHO. ⁴⁶	Access strategies for supranationally procured products are generally better structured and applied more widely. Pentavalent and pneumococcal vaccines, as well as the TB medicines in scope, are procured through organisations including Gavi, GDF and the Stop TB Partnership and distributed to a wide range of eligible countries.	Companies: GSK, Pfizer Products: Pneumococcal 13-valent (Pneumovax [®]), pneumococcal 10-valent (Synflorix [®]) Pneumococcal vaccine prices are negotiated between companies and UNICEF and are made available to Gavi countries at a maximum price of USD 2.90 per dose. GSK and Pfizer have agreed to freeze prices for their pneumococcal vaccines (Pneumovax [®] and Synflorix [®]) in Gavi graduated countries for up to 10 years after graduation.
Price Caps	A price cap or price ceiling is a maximum price that can be charged for a product. A price cap is usually negotiated between a government and a pharmaceutical company to take affordability into account.	To address affordability more efficiently, companies should look at implementing price reductions or price segmentation in more countries, especially low-income countries.	Company: Pfizer Product: Ceftazidime/avibactam (Zavicefta [™]) In 2020, Pfizer implemented a pilot program, capping the price of ceftazidime/avibactam (Zavicefta [™]) to reduce out-of-pocket expenditure for patients.
Product Donations	A short- or long-term donation of products based on the expressed needs of a country. Donations may be made in emergency situations, such as conflict and natural disasters, or may be longer-term to control, eliminate or eradicate a neglected tropical disease (NTD).	Product donations continue to play an important role in controlling, eliminating or eradicating neglected tropical diseases (NTDs) that affect populations living in low- and middle-income countries. For people living in poverty, donations may be their only chance of getting access to the treatment they need.	Company: Pfizer Product: Azithromycin (Zithromax [®]) Pfizer is part of the International Trachoma Initiative (ITI), established in 1998. In 2020, 31.1 million treatments of azithromycin (Zithromax [®]) were shipped to twelve countries through the ITI. As of April 2020, nine countries in scope of the AMR Research Programme have been validated by WHO as having eliminated trachoma as a public health problem. More than 95 million people have benefited from Pfizer's donation programme.
Public-Private Partnership	A public-private partnership (PPP) is a partnership between one or more public organisations and the private sector to provide a public asset or service in which the private party bears significant risk and management responsibility and remuneration is linked to performance. The Access to Medicine Foundation also considers a partnership between a non-profit organisation and the private sector to be a PPP.	Public-private partnerships can be used to expand access to medicines and vaccines by procuring and distributing these products in specific countries or regions. These partnerships can also secure competitive prices and ensure good stewardship practices.	Companies and products: <ul style="list-style-type: none"> • MDR-TB medicine bedaquiline (Sirturo[®]), Johnson & Johnson • MDR-TB medicine delamanid (Deltyba[®]), Otsuka and Viatrix • M/XDR-TB medicine pretomanid (Dovprela), Viatrix Most TB medicines are procured via the GDF Stop TB Partnership, which ensures that national TB control programmes have uninterrupted access to quality-assured medicines by providing direct procurement services and securing competitive prices, contingent on good stewardship practices.
Registration	Filing for registration is a vital first step towards introducing a medical product into a country, as successful registration means that a product is now allowed to be imported and sold. Companies can register their products with the national regulatory authorities of each country by filing dossiers with technical, medical and scientific information.	Registration is an important first step to ensure products are made available for sale, especially in countries with higher levels of disease and inequality. Companies can show a commitment to enter markets in need by filing for registration with local regulatory authorities as widely and rapidly as possible after a product is first approved.	Company: Pfizer Product: Ceftazidime/avibactam (Zavicefta [™]) Pfizer has filed its Reserve antibiotic ceftazidime/avibactam (Zavicefta [™]) for registration in 20 countries in scope of the AMR Research Programme, including three low-income countries (Ethiopia, Tanzania, and Uganda).

Access Strategy	Definition	Context	Company Example
Technology Transfer	A pharmaceutical company transfers knowledge about the process to make a specific medicine or vaccine to a manufacturing site in a country where that product is needed, along with the technology necessary to manufacture it.	Pharmaceutical companies' decisions to transfer technology depends on a variety of factors, such as finding a local partner, local politics and market environment, political stability or good regulatory standards. While low-income countries are not always able to meet these conditions, stable and industrialised upper-middle-income and lower-middle-income countries may present an opportunity for successful technology transfer. ⁴⁷	Companies: Otsuka and Viatriis Product: Delamanid (Delytba®) Otsuka is has initiated a technology transfer to Viatriis for delamanid (Delytba®). The first phase of the technology transfer was completed in 2020, allowing Viatriis to manufacture, package and distribute delamanid in its own licensed countries. The second phase of the technology transfer for full API manufacturing is on-going and was expected to be completed in 2021.
Tenders	A tender is a competitive procurement procedure to supply medicines or vaccines. The tendering process typically comprises price and volume requirements and is commonly used in many countries to encourage competition, particularly in lower-income countries or international agencies procuring on behalf of lower-income countries. ⁴⁶	Tenders can be an effective tool for procurers (e.g., governments or supranational procurement agencies) to secure a volume of medicines or vaccines at a specific price. Tender bidding criteria can include additional aspects such as supply reliability. Tenders often enable to drive competition and ensure the most suitable agreement is secured between the procurer and the company.	Company: Novartis Novartis' tender bidding prices are set using Novartis cost of goods with an added minimum acceptable margin as well as historical data and local insights from key accounts/buyers. Local insights to define the tender price can take into consideration the last awarded prices, the last awarded companies and the maximum tender price determined by the National Health Insurance Scheme concerned.
Tiered Pricing Policy	Tiered pricing, also known as differential pricing, refers to when differing classes of buyers are charged different prices for the same product. In the context of vaccines, low- and middle-income countries can be charged a reduced price compared to high-income countries. ⁴⁸	For most vaccines, companies apply tiered pricing policies that allow them to adjust the prices of their vaccines to countries' ability to pay, setting higher prices in middle- and high-income countries and offering lower prices in low-income countries. In low- and middle-income countries not supported by pooled procurement mechanisms such as Gavi, PAHO or UNICEF, companies still have a responsibility to ensure that ability to pay is taken into account. ⁴⁹	Company: Sanofi Product: DTaP HepB IPV Hib (Hexaxim®) Sanofi applies a tiered pricing policy to price its vaccines, including Hexaxim®. The price is defined based on the channel of distribution and the GNI per capita.
Voluntary Licensing	A voluntary license is an authorisation given by the patent holder to a generic medicine manufacturer, allowing the manufacturer to produce the patented medicine or vaccine, often at a lower cost. The license usually sets quality requirements and defines the countries in which the licensee can sell the product. ⁵⁰	How large research-based pharmaceutical companies manage their intellectual property impacts the availability and affordability of medicines and vaccines. For example, when rights-holding companies enable generic medicine manufacturers to develop generic versions of their medicines, it can increase their affordability, support supply, foster competition and ultimately improve access. This is achieved through the use of a non-exclusive voluntary license – one important approach among many to making a product accessible.	Companies: Otsuka and Viatriis Product: Delamanid (Delytba®) Otsuka has a voluntary licensing agreement with Viatriis to accelerate access to delamanid in high TB burden countries, enabling delamanid to be locally manufactured in India and resulting in a lower-cost generic version.

API: Active Pharmaceutical Ingredient; GDF: Global Drug Facility; GNI: Gross National Income; MDR-TB: Multidrug-resistant tuberculosis; M/XDR-TB: Multidrug- and extensively drug-resistant tuberculosis; NGO: non-governmental organization; PAHO: Pan American Health Organization; TB: tuberculosis; UNICEF: United Nations Children's Fund; WHO: World Health Organization.

DEFINITIONS

Access strategy

Pharmaceutical companies use access strategies to expand access to their medicines in low- and middle-income countries. An access strategy includes all activities and processes that pharmaceutical companies undertake to secure a price and define a target population, while ensuring access to the product short- and/or long-term. The strategy may apply to a defined set of diseases, products, therapeutic areas or to a subset of their portfolio.

Active pharmaceutical ingredient (API)

The active pharmaceutical ingredient (API) is the active pharmaceutical component of a medicine that carries out its intended effects. Some medicines, such as combination therapies, have multiple active ingredients that target multiple disease pathways and/or symptoms. The inactive ingredients of a medicine are referred to as excipients.

Antibacterial medicine

Antimicrobial medicine used to treat bacterial infections by directly targeting the bacteria that causes the infection or the disease process (as opposed to targeting the symptoms of the infection). Biocides are not considered antibacterial medicines. See also Antibiotics.

Antibiotics

Equivalent to Antibacterial medicine. The term “antibiotic” is often used inconsistently in literature to denote either a drug that targets any type of microorganism in the body or, alternatively, a drug that targets bacteria specifically.

Antifungal medicine

Antimicrobial medicine used to treat fungal infections by directly targeting the fungi that causes the infection (as opposed to targeting the symptoms of the infection or toxins produced by the pathogen).

Antimicrobial resistance (AMR)

Antimicrobial resistance is the ability of microbes such as bacteria, viruses, fungi and parasites (protozoa or helminths) to grow in the presence of an antimicrobial substance (e.g., a medicine) that would normally kill them or limit their growth. Resistance is a consequence of evolution via natural or artificial selection.

Antibacterial resistance

Antibacterial resistance is the ability of bacteria to become resistant to antibacterial medicines through mutational resistance and horizontal gene transfer. Mutational resistance occurs when bacteria develop mutations in genes that affect the activity of the antibacterial medicine. Horizontal gene transfer is the acquisition of genetic information by transfer from an organism that is not its parent.

Appropriate access

Improving the availability, affordability and accessibility of antimicrobial medicines and vaccines while ensuring that these products are being used responsibly by limiting their overuse and misuse to ensure they stay effective for as long as possible.

Broad-spectrum antibiotics

Broad-spectrum antibiotics are antibacterial medicines that are active against a wide range of bacterial types and may be used to treat a wide range of bacterial infections.

Extensively drug-resistant tuberculosis (XDR-TB)

Extensively drug-resistant tuberculosis is a rare type of multidrug-resistant tuberculosis that is resistant to isoniazid and rifampin, plus any fluoroquinolone and at least one of three injectable second-line medicines (i.e., amikacin, kanamycin or capreomycin).

Generic medicine

A medicine that is created to be the same as a known marketed brand-name drug (the originator medicine) in dosage form, strength, route of administration, quality and performance characteristics, and intended use. See also Originator medicine.

Gram-negative bacteria

Gram-negative bacteria are bacteria that do not retain the crystal violet stain used in the Gram staining method of bacterial differentiation due to their bacterial cell wall.

Healthcare Professional (HCP)

Any specialised worker in any branch of healthcare that provides preventive, curative or rehabilitative services to the community.

Multi-drug resistant tuberculosis (MDR-TB)

Multi-drug resistant tuberculosis is caused by tuberculosis that is resistant to treatment with at least isoniazid and rifampin, which are the two most potent tuberculosis medicines.

Narrow-spectrum antibiotics

Narrow-spectrum antibiotics are antibacterial medicines that are active against a selected group of bacterial types. Examples include colistin, an antibacterial that selectively targets gram-negative bacteria, and vancomycin, an antibacterial that selectively targets gram-positive bacteria.

Off-patent medicine

A medicine for which the granted patent protection has expired. Patent protection typically lasts for 20 years and is specific to each country.

On-patent/patented medicine

A patented or on-patent medicine is a medicine that has received exclusivity rights, allowing the patent holder to prevent or stop others from making, using, selling or importing the medicine within the country that granted the patent. The Antimicrobial Resistance Benchmark research programme determines patent status for its products in scope through a process that combines data from selected regulatory authority websites (e.g., the US FDA) and participating companies.

Originator medicine

The medicine that was first authorised worldwide for marketing, normally as a patented product, on the basis of its documented efficacy, safety and quality, according to requirements at the time of authorisation. The originator medicine always has a brand name; this name may, however, vary among countries.

Over-the-counter medicine

A medicine that can be purchased without prescription from a healthcare professional.

Pull incentive

Pull incentives, in the form of extended exclusivity periods, higher reimbursement or market entry rewards, reward companies for bringing new drugs to the market through lowering the uncertainty for return on investment.

Push incentive

Push incentives, in the form of grants, partnerships or tax credits, are employed to lower the cost of and de-risk research and development of a new medicine.

Stewardship

A systematic and comprehensive process that aims to ensure that all aspects of prescription (e.g., drug, dose and duration), dispensing and the use of antimicrobial medicines are consistent with the available evidence on how to minimise the emergence of antimicrobial resistance.

REFERENCES

- Murray CJ, Ikuta KS, Sharara F, et al. Global burden of bacterial antimicrobial resistance in 2019: a systematic analysis. *Lancet*. 2022;399(10325):629–655. doi:10.1016/S0140-6736(21)02724-0
- Jim O'Neill. *Antimicrobial Resistance: Tackling a Crisis for the Health and Wealth of Nations*; 2014.
- Hocking L, Ali G-C, D'angelo C, et al. *How Is Modern Medicine Being Affected by Drug-Resistant Infections?* United Kingdom
- World Health Organization. Antibiotic resistance. Geneva. <https://www.who.int/news-room/fact-sheets/detail/antibiotic-resistance#:~:text=Antibiotic resistance occurs naturally%2C but,treat them become less effective.> Published July 31, 2020. Accessed April 20, 2022.
- Kallberg C, Ardal C, Blix HS, et al. Introduction and geographic availability of new antibiotics approved between 1999 and 2014. *PLoS One*. 2018;13(10). doi:10.1371/journal.pone.0205166
- Access to Medicine Foundation. *Antimicrobial Resistance Benchmark 2018*. Amsterdam; 2018. www.amr-benchmark.org.
- Access to Medicine Foundation. *Antimicrobial Resistance Benchmark 2020*. Amsterdam; 2020.
- Access to Medicine Foundation. *Antimicrobial Resistance Benchmark 2021*. Amsterdam; 2021. https://access-to-medicinefoundation.org/media/uploads/downloads/61ee760d03810_Antimicrobial Resistance Benchmark report 2021.pdf. Accessed April 8, 2022.
- Fisher MC, Alastruey-Izquierdo A, Berman J, et al. Tackling the emerging threat of antifungal resistance to human health. *Nat Rev Microbiol*. March 2022. doi:10.1038/s41579-022-00720-1
- World Health Organization. WHO releases the 2019 AWARe Classification Antibiotics. Geneva. Published October 1, 2019. Accessed May 17, 2022. <https://www.who.int/news/item/01-10-2019-who-releases-the-2019-aware-classification-antibiotics>
- Benjamin Plackett. No money for new drugs. *Nature*. 2020;586:550–552.
- Medicines and Healthcare products Regulatory Agency. International Strategy. Published online. https://assets.publishing.service.gov.uk/government/uploads/system/uploads/attachment_data/file/609425/Item_10__2017-OB-05__International_Strategy.pdf. Published 2017. Accessed April 26, 2022.
- Access to Medicine Foundation. *Global Health Security: Addressing the Threat of Short Supplies of Essential Medicines and Vaccines*; 2022. Accessed May 12, 2022. <https://accessmedicinefoundation.org/publications/amsterdam-session-on-global-health-security-meeting-report>
- Tolla HS, Asemere YA, Desale AY, et al. Changes in the availability of medical oxygen and its clinical practice in Ethiopia during a national scale-up program: a time series design from thirty-two public hospitals. *BMC Pediatr*. 2021;21(1):1–9. doi:10.1186/S12887-021-02844-4/FIGURES/5
- Clive Cookson. UK launches world-first 'subscription' model for antibiotic supply. *Financial Times*. <https://www.ft.com/content/c7cbebe4-8597-4340-8c55-56c4b423c1d1>. Published April 12, 2022. Accessed April 12, 2022.
- Access to Medicine Foundation. *Biotech's Are Saving the World from Superbugs. Can They Also Save Themselves?* Amsterdam; 2021. https://accessmedicinefoundation.org/media/uploads/downloads/60c10465e10do_ATMF_Biotech's_And_Superbugs_2021.pdf. Accessed April 8, 2022.
- Michael Conway, Tania Holt, Adam Sabow, Irene Yuan Sun. Should sub-Saharan Africa make its own drugs? McKinsey & Company. <https://www.mckinsey.com/industries/public-and-social-sector/our-insights/should-sub-saharan-africa-make-its-own-drugs>. Published January 10, 2019. Accessed March 31, 2022.
- Médecins Sans Frontières. Lifesaving TB medicines still out of reach for children in high-burden countries. <https://www.msf.org/lifesaving-tb-medicines-still-out-reach-children-high-burden-countries>. Published September 3, 2021. Accessed April 11, 2022.
- Médecins Sans Frontières. *MSF Analysis of Gilead Hepatitis C License*; 2015. <https://msfaccess.org/msf-analysis-gilead-hepatitis-c-license>. Accessed April 11, 2022.
- IQVIA. *Midas Anti-Infectives Data*; 2017.
- United Nations Africa Renewal. Dying from lack of medicines. <https://www.un.org/africarenewal/magazine/december-2016-march-2017/dying-lack-medicines>. Published 2017. Accessed April 13, 2022.
- Awucha NE, JaneFrances OC, Meshach AC, Henrietta JC, Daniel AI, Chidiebere NE. Impact of the COVID-19 Pandemic on Consumers' Access to Essential Medicines in Nigeria. *Am J Trop Med Hyg*. 2020;103(4):1630. doi:10.4269/AJTMH.20-0838
- Abubakar U. Antibiotic use among hospitalized patients in northern Nigeria: A multicenter point-prevalence survey. *BMC Infect Dis*. 2020;20(1):1–9. doi:10.1186/S12879-020-4815-4/TABLES/4
- The World Bank. Nigeria: Development news, research, data. <https://www.worldbank.org/en/country/nigeria>. Accessed April 13, 2022.
- Nigeria's National Agency for Food and Drug Administration and Control. Five Plus Five-Year Validity (Migration* to Local Production*). <https://www.nafdac.gov.ng/five-plus-five-year-validity-migration-to-local-production-03191/>. Accessed March 31, 2022.
- World Health Organization. Egypt and Nigeria medicines regulators achieve high maturity level in WHO classification and WHO launches list of regulatory authorities that meet international standards. Geneva. <https://www.who.int/news/item/30-03-2022-egypt-and-nigeria-medicines-regulators-achieve-high-maturity-level-in-who-classification-and-who-launches-list-of-regulatory-authorities-that-meet-international-standards>. Published March 30, 2022. Accessed April 6, 2022.
- Global Action Fund for Fungal Infections, International Treatment Preparedness Coalition, National Institute for Communicable Diseases SA, et al. *Ending Cryptococcal Meningitis Deaths by 2030 – Strategic Framework*. South Africa; 2021.
- Rajasingham R, Smith RM, Park BJ, et al. Global burden of disease of HIV-associated cryptococcal meningitis: an updated analysis. *Lancet Infect Dis*. 2017;17(8):873–881. doi:10.1016/S1473-3099(17)30243-8
- Molloy SF, Kanyama C, Heyderman RS, et al. Antifungal Combinations for Treatment of Cryptococcal Meningitis in Africa. *N Engl J Med*. 2018;378(11):1004–1017. doi:10.1056/nejmoa1710922
- Shroufi A, Govender NP, Meintjes G, et al. Time to embrace access programmes for medicines: lessons from the South African flucytosine access programme. *Int J Infect Dis*. 2020;95:459–461. doi:10.1016/j.ijid.2020.02.057
- Government of South Africa. Medicines and Related Substances Act (previously Drugs Control Act) 101 of 1965. <https://www.gov.za/documents/drugs-control-act-7-jul-1965-00004#:~:text=The Medicines and Related Substances,for matters incidental thereto.> Accessed April 12, 2022.
- Clinton Health Access Initiative. *HIV Market Report: The State of HIV Treatment, Testing, and Prevention in Low- and Middle-Income Countries*; 2020.
- World Health Organization. Mucormycosis. Geneva. [https://www.who.int/india/emergencies/coronavirus-disease-\(covid-19\)/mucormycosis](https://www.who.int/india/emergencies/coronavirus-disease-(covid-19)/mucormycosis). Accessed April 7, 2022.
- Narayanan S, Chua J V, Baddley JW. Coronavirus Disease 2019–Associated Mucormycosis: Risk Factors and Mechanisms of Disease. *Clin Infect Dis*. August 2021. doi:10.1093/cid/ciab726
- Shionogi. Shionogi Announces FDA Approval of FETROJA® (Cefiderocol) for the Treatment of Hospital-Acquired Bacterial Pneumonia and Ventilator-Associated Bacterial Pneumonia. <https://www.shionogi.com/us/en/news/2020/9/shionogi-announces-fda-approval-of-fetroja-cefiderocol-for-the-treatment-of-hospital-acquired-bacterial-pneumonia-and-ventilator-associated-bacterial-pneumonia.html>. Published September 28, 2020. Accessed March 30, 2022.
- Zhanell GG, Golden AR, Zelenitsky S, et al. Cefiderocol: A Siderophore Cephalosporin with Activity Against Carbapenem-Resistant and Multidrug-Resistant Gram-Negative Bacilli. *Drugs*. 2019;79(3):271–289. doi:10.1007/s40265-019-1055-2
- Shionogi. GARDP, CHAI and Shionogi announce MOU to increase access to antibiotic to treat antimicrobial resistant infections in low- and middle-income countries. <https://www.shionogi.com/global/en/news/2021/07/e-210713.html>. Published July 13, 2021. Accessed March 4, 2022.
- Global Antibiotic Research and Development Partnership. Global Antibiotic R&D Partnership (GARDP) on Twitter. https://twitter.com/gardp_amr/status/1458104744644390924. Published November 9, 2021. Accessed March 30, 2022.
- Otsuka. Otsuka and Mylan Announce License Agreement to Commercialize Delamanid (Delyba™) for Multidrug-Resistant Tuberculosis (MDR-TB) in High-Burden Countries.
- Pfizer. Pfizer Launches 'An Accord for a Healthier World' to Improve Health Equity for 1.2 Billion People Living in 45 Lower-Income Countries. Published May 25, 2022. Accessed May 25, 2022. <https://www.pfizer.com/news/press-release/press-release-detail/pfizer-launches-accord-healthier-world-improve-health>
- United Nations Conference on Trade and Development. *Key Statistics and Trends in Regional Trade in Africa*; 2019. <https://unctad.org/webflyer/key-statistics-and-trends-regional-trade-africa>. Accessed April 12, 2022.
- World Health Organization. The mRNA vaccine technology transfer hub. Geneva. <https://www.who.int/initiatives/the-mrna-vaccine-technology-transfer-hub>. Published 2021. Accessed April 13, 2022.
- Medicines Patent Pool. WHO and MPP announce names of 15 manufacturers to receive training from mRNA technology transfer hub. <https://medicinespatentpool.org/news-publications-post/who-and-mpp-announce-names-of-15-manufacturers-to-receive-training-from-mrna-technology-transfer-hub>. Published April 19, 2022. Accessed April 19, 2022.
- Global Antibiotic Research and Development Partnership. SECURE: Expanding Sustainable Access to Antibiotics. <https://www.gardp.org/what-we-do/secure/>. Accessed March 31, 2022.
- Patil S. Early access programs: Benefits, challenges, and key considerations for successful implementation. *Perspect Clin Res*. 2016;7(1):4. doi:10.4103/2229-3485.173779
- World Health Organization. WHO guideline on country pharmaceutical pricing policies. Geneva. <https://www.who.int/publications/i/item/9789240011878>. Published January 1, 2015. Accessed April 12, 2022.
- International Federation of Pharmaceutical Manufacturers & Associations. The Research-Based Pharmaceutical Industry Experience. 2015.
- The World Bank, GAVI Alliance. Immunization Financing Toolkit. <https://openknowledge.worldbank.org/bitstream/handle/10986/20784/2924760WP0ImmunooBox385358B00PUBLIC0.pdf?sequence=1&isAllowed=y>. Published 2010. Accessed April 12, 2022.
- Gavi The Vaccine Alliance. Pneumococcal vaccine support. <https://www.gavi.org/types-support/vaccine-support/pneumococcal>. Published 2021. Accessed October 21, 2021.
- International Federation of Pharmaceutical Manufacturers & Associations. Voluntary licenses and non-assert declarations. <https://www.ifpma.org/resource-centre/voluntary-licenses-and-non-assert-declarations/>. Published July 28, 2010. Accessed April 12, 2022.

Report Design

Scribble Design

Photo Disclaimer

The Access to Medicine Foundation gratefully respects the permission granted to reproduce the copyright material in this report. Every reasonable effort has been made to trace copyright holders and to obtain their permission for the use of copyright material. Should you believe that any content in this report does infringe any rights you may possess, please contact us at info@accesstomedicinefoundation.org or +31 (0) 20 21 53 535.

Disclaimer

As a multi-stakeholder and collaborative project, the findings, interpretations and conclusions expressed herein may not necessarily reflect the views of all members of the stakeholder groups or the organisations they represent. The report is intended to be for information purposes only and is not intended as promotional material in any respect. The material is not intended as an offer or solicitation for the purchase or sale of any financial instrument. The report is not intended to provide accounting, legal or tax advice or investment recommendations. Whilst based on information believed to be reliable, no guarantee can be given that it is accurate or complete.

Copyright and sharing parts of this report

You are free to:

Share — copy and redistribute the material in any medium or format.

The licensor cannot revoke these freedoms as long as you follow the license terms.

Under the following terms:

Attribution — You must give appropriate credit, provide a link to the license, and indicate if changes were made. You may do so in any reasonable manner, but not in any way that suggests the licensor endorses you or your use.

NonCommercial — You may not use the material for commercial purposes.

NoDerivatives — If you remix, transform, or build upon the material, you may not distribute the modified material.

No additional restrictions — You may not apply legal terms or technological measures that legally restrict others from doing anything the license permits.

Notices:

No warranties are given. The license may not give you all of the permissions necessary for your intended use. For example, other rights such as publicity, privacy, or moral rights may limit how you use the material. For more information on how you can use this report, please contact us at info@accesstomedicinefoundation.org or +31 (0) 20 21 53 535.



ACCESS TO
MEDICINE
FOUNDATION

Access to Medicine Foundation

Naritaweg 227A
1043 CB Amsterdam
The Netherlands

www.accesstomedicinefoundation.org
info@accesstomedicinefoundation.org
+31 (0)20 21 53 535